

# POPLAR BEACH

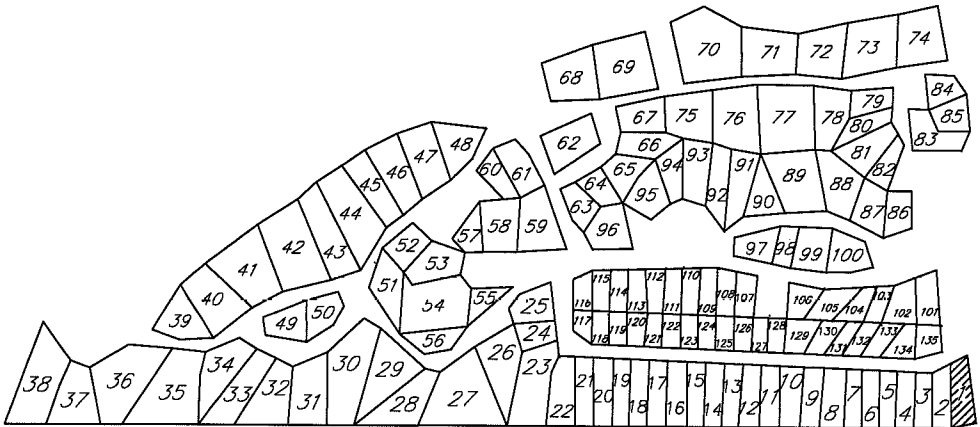

## R.V. RESORT

WAKAW LAKE, SASK.



### LEGEND

- Light Pole
- Septic Tank Lid
- ⊗ Water Valve
- Electrical Outlet
- Ⓟ Telephone Pedestal
- ◆ 0.013 X 0.450 m small iron post

### KEY PLAN

HIGHWAY 41

FOCH STREET

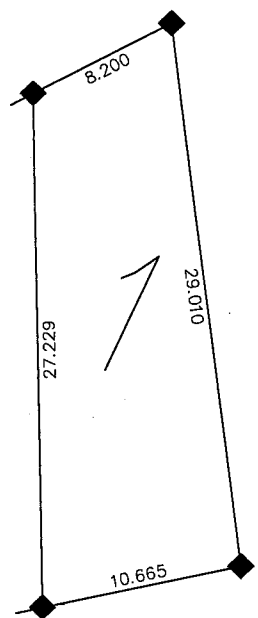

**AREA**  
 sq. m. = 254.71  
 sq. ft. = 2741.7

SCALE  
 1: 400

PREPARED BY:  
  
**Webb Surveys**  
 07-1622cs B/J

# POPLAR BEACH



## R.V. RESORT

WAKAW LAKE, SASK.

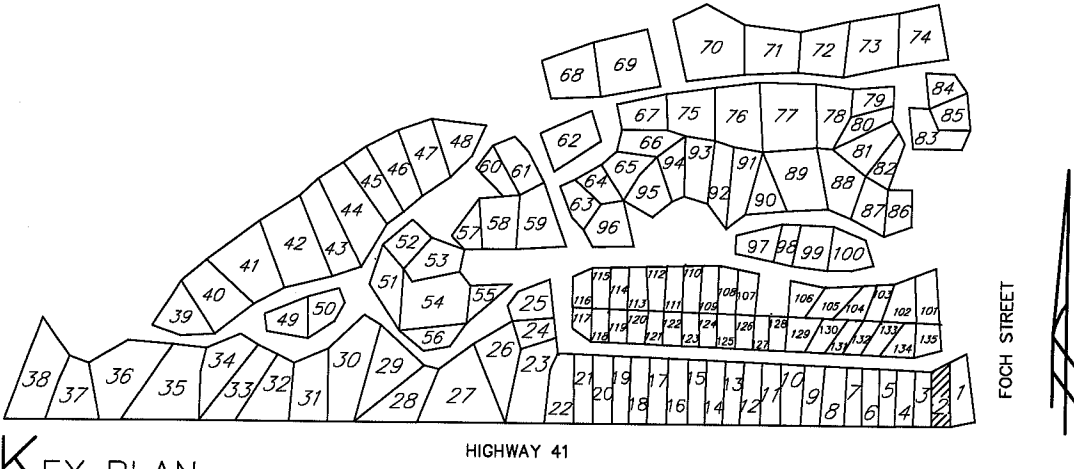

### LEGEND

- Light Pole
- Septic Tank Lid
- ⊗ Water Valve
- Electrical Outlet
- Telephone Pedestal
- ◆ 0.013 X 0.450 m small iron post

### KEY PLAN

HIGHWAY 41

FOCH STREET

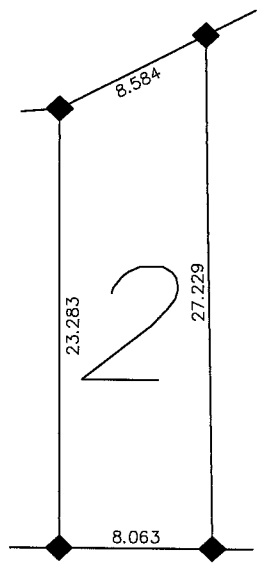

AREA	
sq. m.	= 199.05
sq. ft.	= 2142.5

SCALE  
1:400

PREPARED BY:

**Webb Surveys**

07-1622cs B/JF

# POPLAR BEACH



## R.V. RESORT

WAKAW LAKE, SASK.

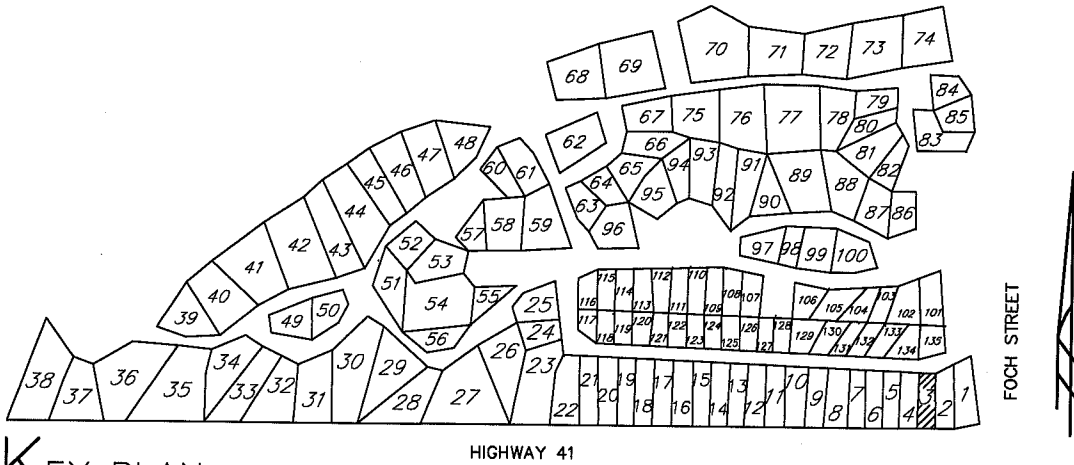

### LEGEND

- Light Pole
- Septic Tank Lid
- ⊗ Water Valve
- Electrical Outlet
- ⊞ Telephone Pedestal
- ◆ 0.013 X 0.450 m small iron post

## KEY PLAN

HIGHWAY 41

FOCH STREET

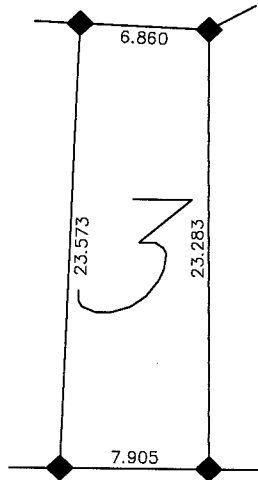

**AREA**  
 sq. m. = 172.87  
 sq. ft. = 1860.8

SCALE  
 1:400

PREPARED BY:  
  
 07-1622cs BJB

# POPLAR BEACH



## R.V. RESORT

WAKAW LAKE, SASK.

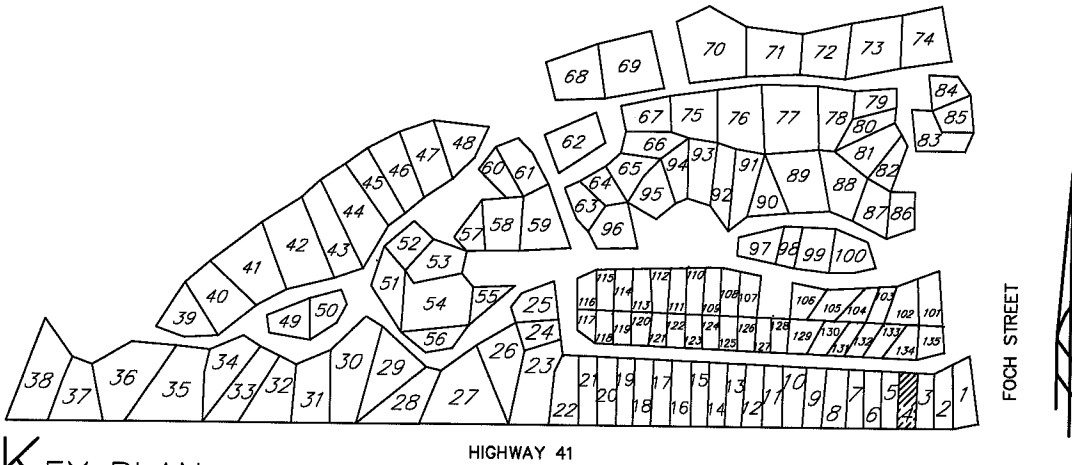

### LEGEND

- Light Pole
- Septic Tank Lid
- ⊗ Water Valve
- Electrical Outlet
- Ⓟ Telephone Pedestal
- ◆ 0.013 X 0.450 m small iron post

## KEY PLAN

HIGHWAY 41

FOCH STREET

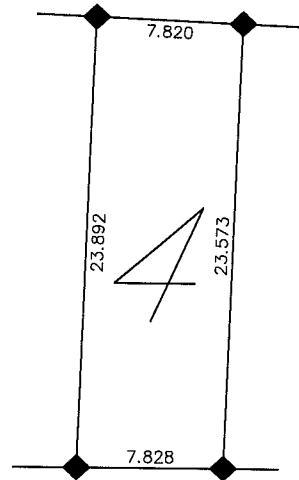

**AREA**  
 sq. m. = 185.64  
 sq. ft. = 1998.2

SCALE  
 1:400

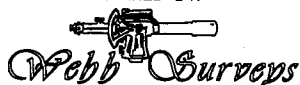
PREPARED BY:  
  
 07-1622cs B.J.F.

# POPLAR BEACH



## R. V. RESORT

WAKAW LAKE, SASK.

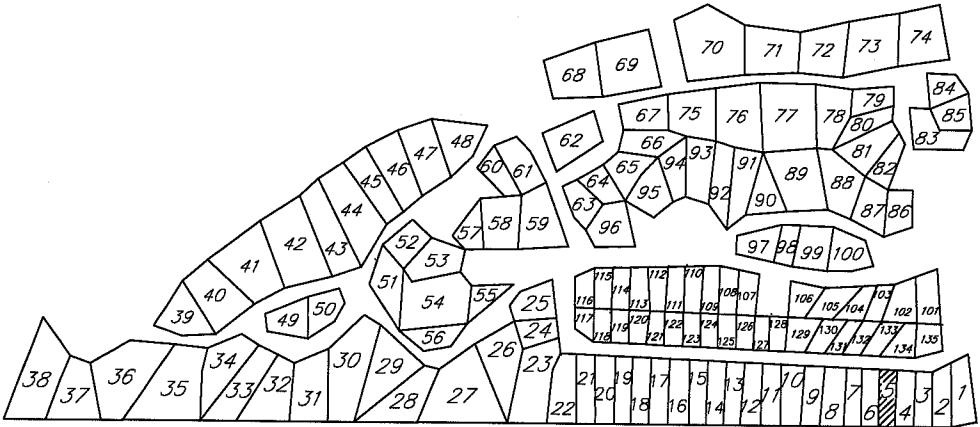

### LEGEND

- Light Pole
- Septic Tank Lid
- ⊗ Water Valve
- Electrical Outlet
- Ⓟ Telephone Pedestal
- ◆ 0.013 X 0.450 m small iron post

### KEY PLAN

HIGHWAY 41

FOCH STREET

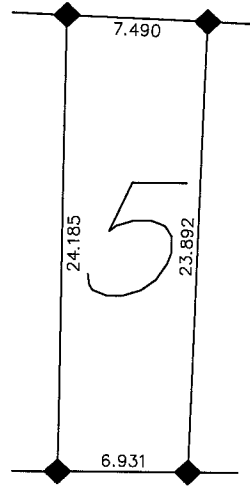

<b>AREA</b>	
sq. m.	= 173.29
sq. ft.	= 1865.2

SCALE  
1: 400

PREPARED BY:  
  
**Webb Surveys**  
 07-1622cs BJB

# POPLAR BEACH



## R.V. RESORT

WAKAW LAKE, SASK.

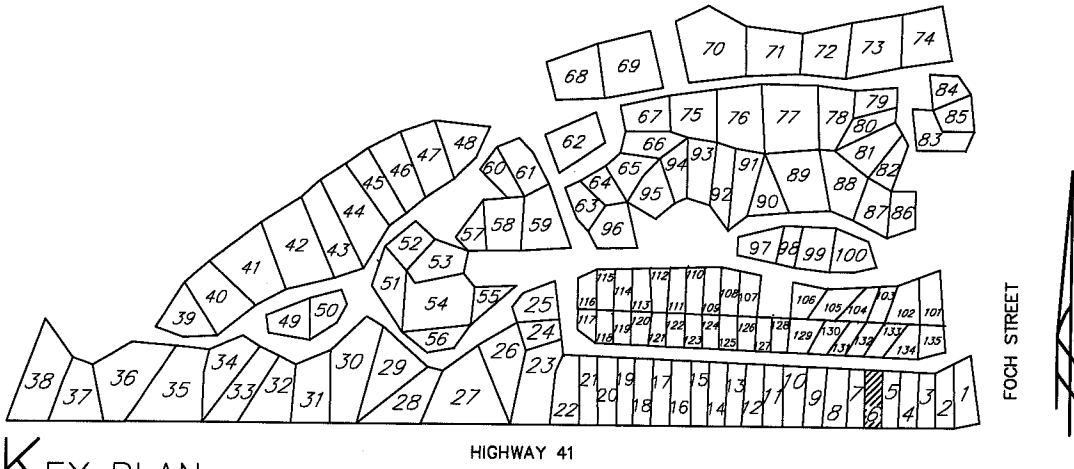

### LEGEND

- Light Pole
- Septic Tank Lid
- ⊗ Water Valve
- Electrical Outlet
- Telephone Pedestal
- ◆ 0.013 X 0.450 m small iron post

### KEY PLAN

HIGHWAY 41

FOCH STREET

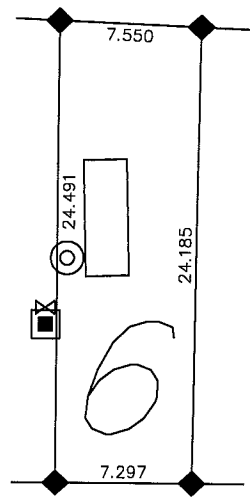

**AREA**  
 sq. m. = 180.61  
 sq. ft. = 1944.0

SCALE  
 1:400

PREPARED BY:  
  
**Webb Surveys**  
 07-1622cs B.J.F.

# POPLAR BEACH



## R. V. RESORT

WAKAW LAKE, SASK.

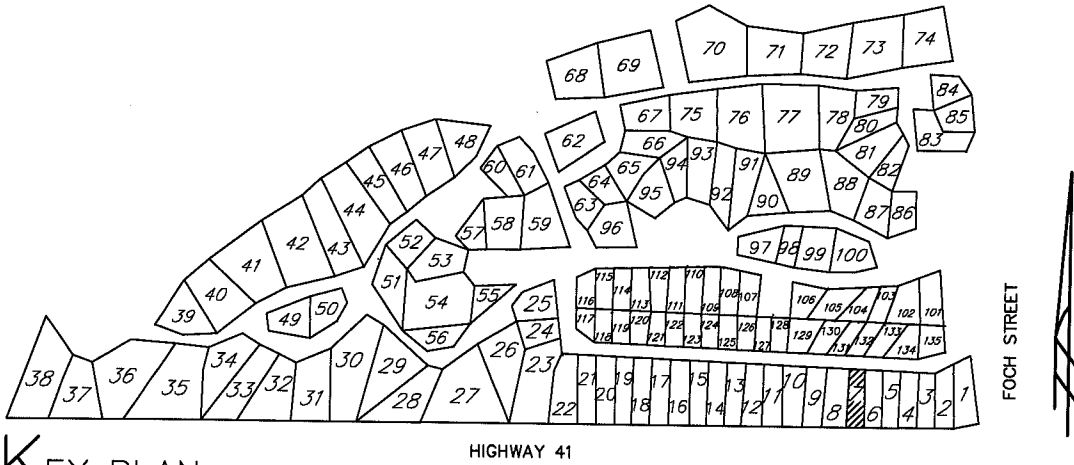

### LEGEND

- Light Pole
- ⊙ Septic Tank Lid
- ⊗ Water Valve
- Electrical Outlet
- Ⓟ Telephone Pedestal
- ◆ 0.013 X 0.450 m small iron post

### KEY PLAN

HIGHWAY 41

FOCH STREET

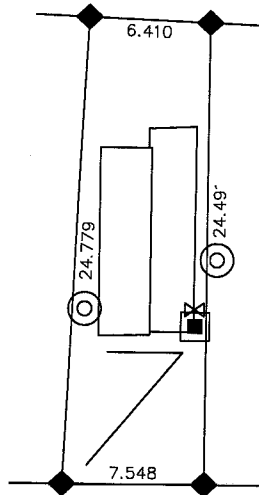

AREA	
sq. m.	= 171.85
sq. ft.	= 1849.7

SCALE  
1: 400

PREPARED BY:

Webb Surveys

07-1622cs BJF

# POPLAR BEACH



## R. V. RESORT

WAKAW LAKE, SASK.

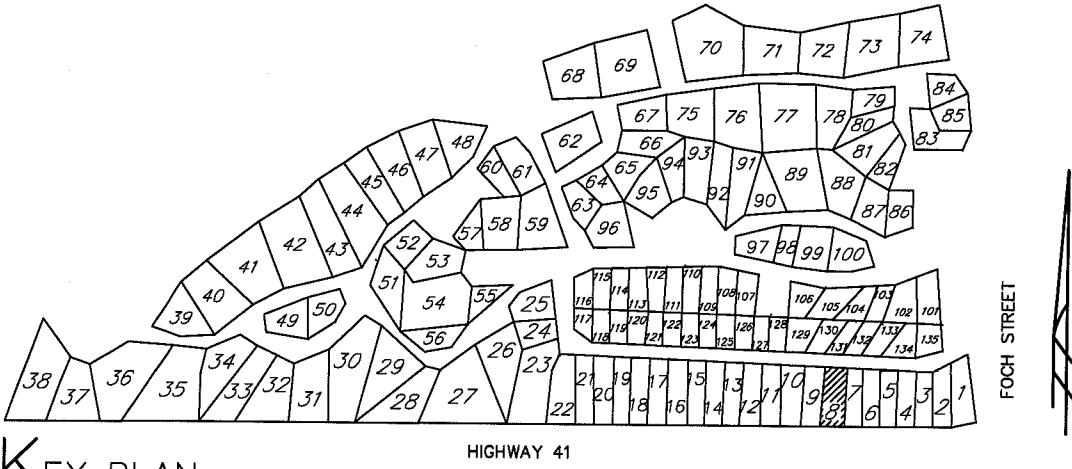

### LEGEND

- Light Pole
- Septic Tank Lid
- ⊗ Water Valve
- Electrical Outlet
- Ⓟ Telephone Pedestal
- ◆ 0.013 X 0.450 m small iron post

### KEY PLAN

HIGHWAY 41

FOCH STREET

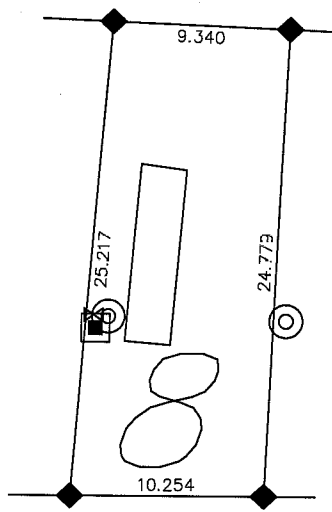

AREA	
sq. m.	= 244.57
sq. ft.	= 2632.5

SCALE  
1: 400

PREPARED BY:  
  
**Webb Surveys**  
 07-1622cs B.J.F.



# POPLAR BEACH



## R. V. RESORT

WAKAW LAKE, SASK.

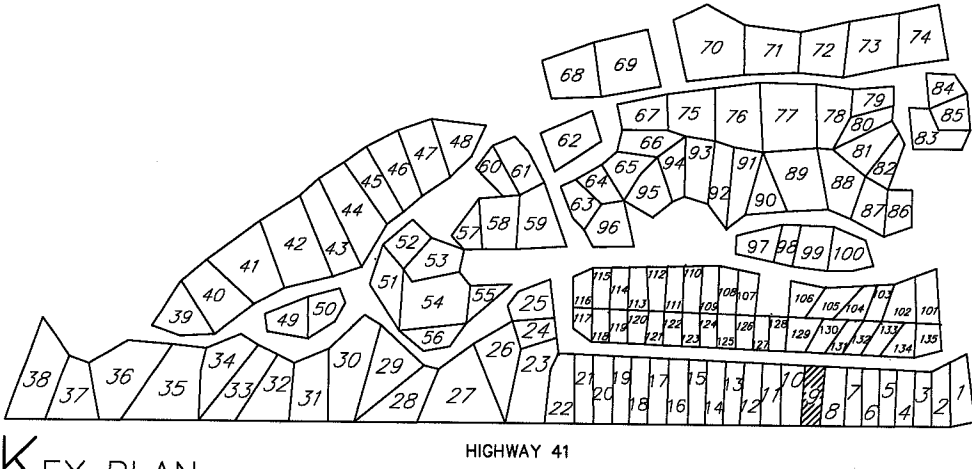

### LEGEND

- Light Pole
- Septic Tank Lid
- ⊗ Water Valve
- Electrical Outlet
- P Telephone Pedestal
- ◆ 0.013 X 0.450 m small iron post

FOCH STREET

HIGHWAY 41

### KEY PLAN

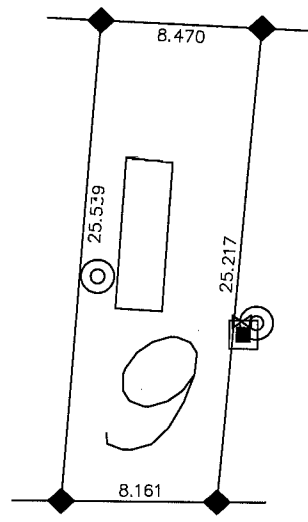

AREA	
sq. m.	= 210.67
sq. ft.	= 2267.6

SCALE  
1: 400

PREPARED BY:  
  
**Webb Surveys**  
 07-1622cs B.J.F.

# POPLAR BEACH



## R. V. RESORT

WAKAW LAKE, SASK.

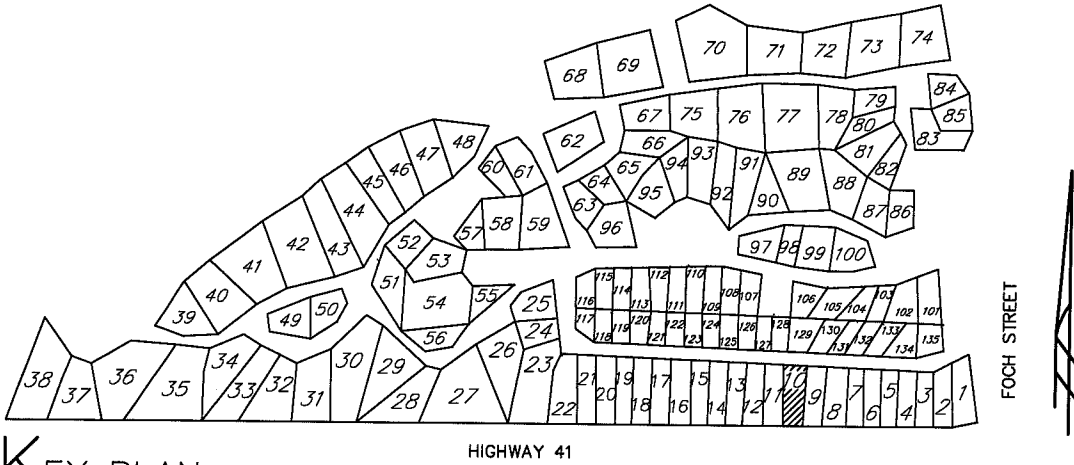

### KEY PLAN

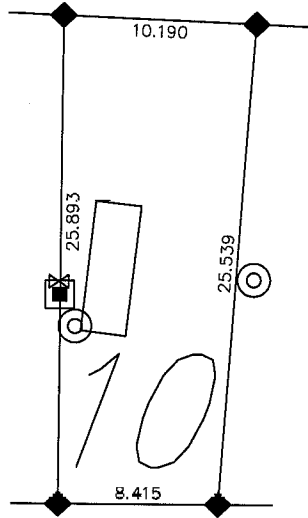

AREA	
sq. m.	= 239.02
sq. ft.	= 2572.8

SCALE  
1:400

PREPARED BY:  
  
**Webb Surveys**  
 07-1622cs BJF

# POPLAR BEACH



## R.V. RESORT

WAKAW LAKE, SASK.

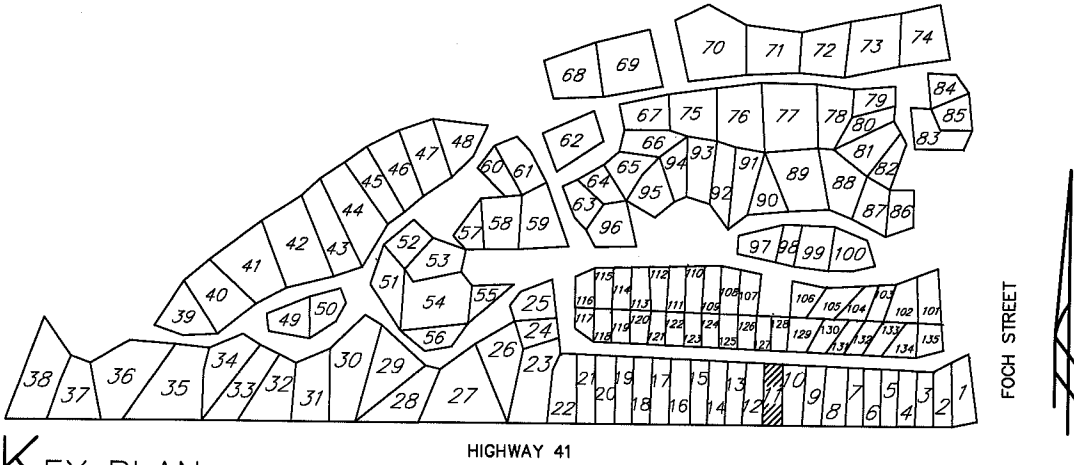

### KEY PLAN

HIGHWAY 41

FOCH STREET

#### LEGEND

- Light Pole
- Septic Tank Lid
- ⊗ Water Valve
- Electrical Outlet
- P Telephone Pedestal
- ◆ 0.013 X 0.450 m small iron post

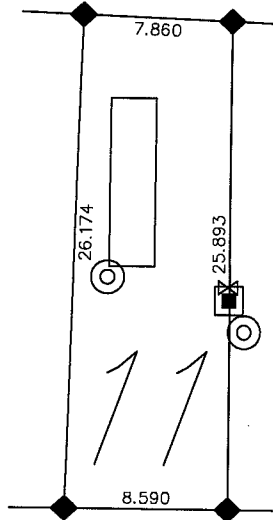

**AREA**  
 sq. m. = 214.06  
 sq. ft. = 2304.2

SCALE  
 1: 400

PREPARED BY:  
  
**Webb Surveys**  
 07-1622cs BJF

# POPLAR BEACH



## R.V. RESORT

WAKAW LAKE, SASK.

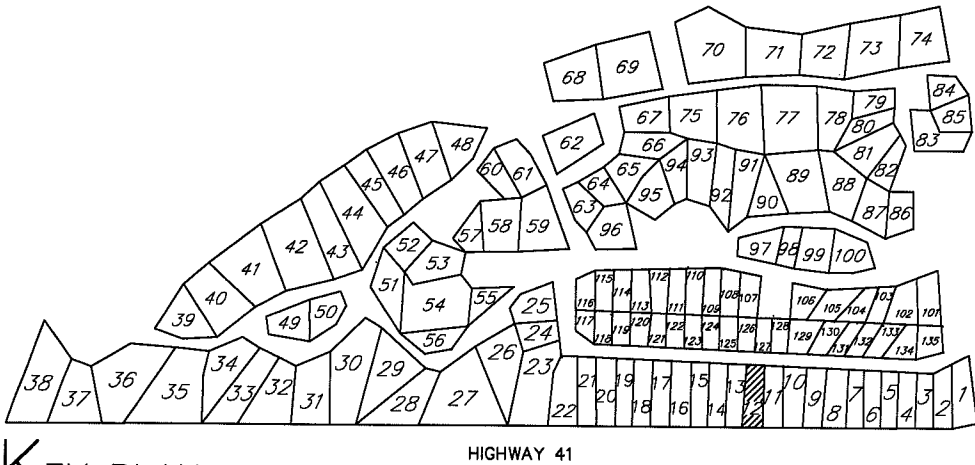

### LEGEND

- Light Pole
- Septic Tank Lid
- ⊗ Water Valve
- Electrical Outlet
- Telephone Pedestal
- ◆ 0.013 X 0.450 m small iron post

### KEY PLAN

HIGHWAY 41

FOCH STREET

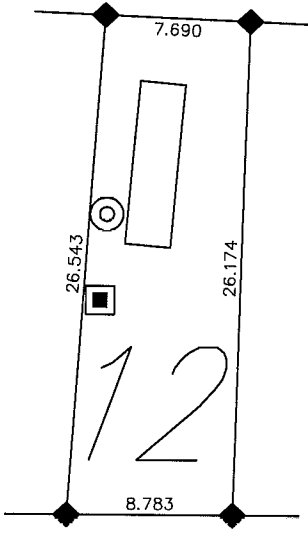

AREA	
sq. m.	= 216.92
sq. ft.	= 2334.9

SCALE  
1: 400

PREPARED BY:  
  
**Webb Surveys**  
 07-1622cs B.J.F.

# POPLAR BEACH



## R.V. RESORT

WAKAW LAKE, SASK.

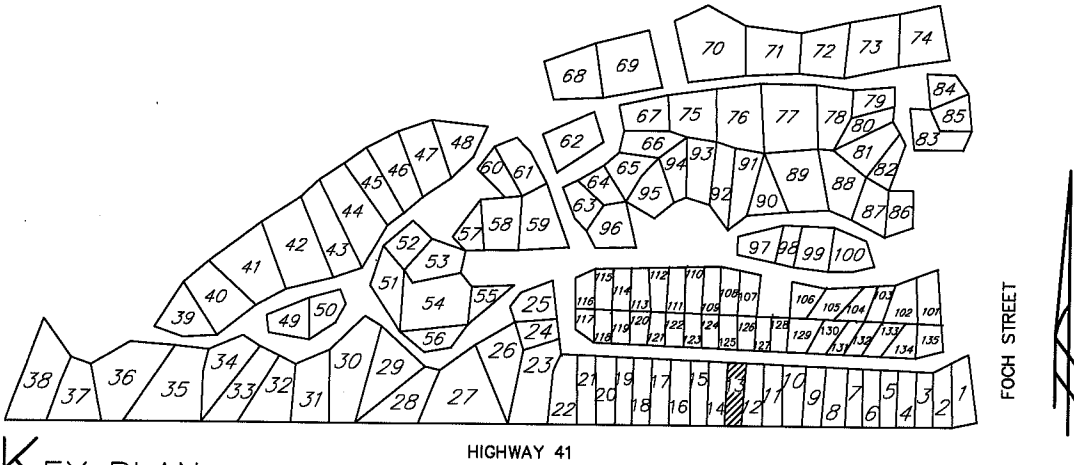

### KEY PLAN

HIGHWAY 41

FOCH STREET

#### LEGEND

- Light Pole
- Septic Tank Lid
- ⊗ Water Valve
- Electrical Outlet
- Telephone Pedestal
- ◆ 0.013 X 0.450 m small iron post

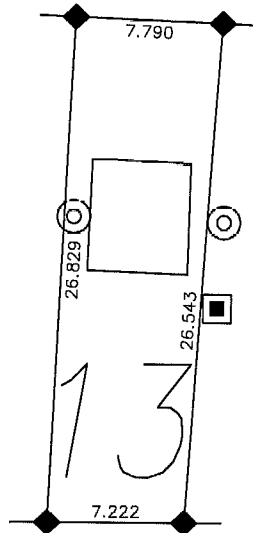

<b>AREA</b>	
sq. m.	= 200.11
sq. ft.	= 2154.0

SCALE  
1:400

PREPARED BY:  
  
**Webb Surveys**  
 07-1622cs B.J.F.

# POPLAR BEACH



## R.V. RESORT

WAKAW LAKE, SASK.

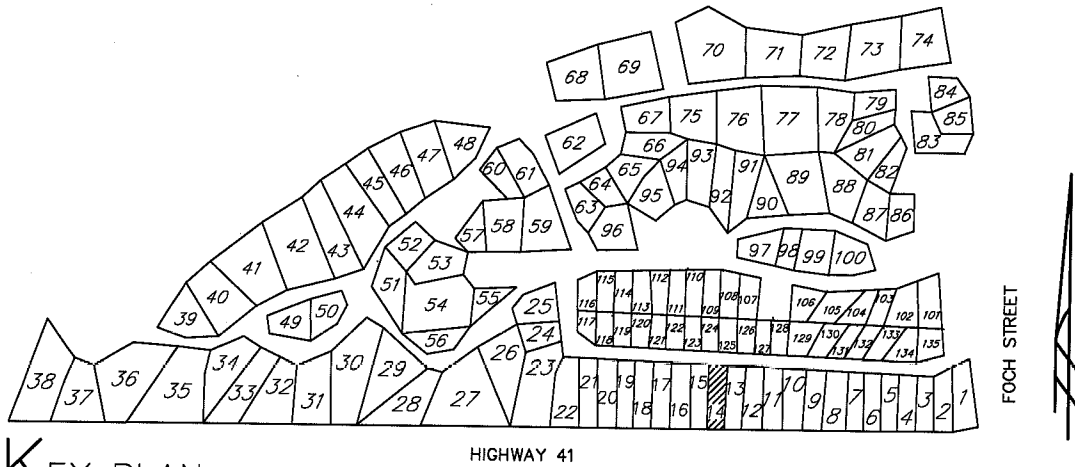

KEY PLAN

**LEGEND**

- Light Pole
- Septic Tank Lid
- ⊗ Water Valve
- Electrical Outlet
- Telephone Pedestal
- ◆ 0.013 X 0.450 m small iron post

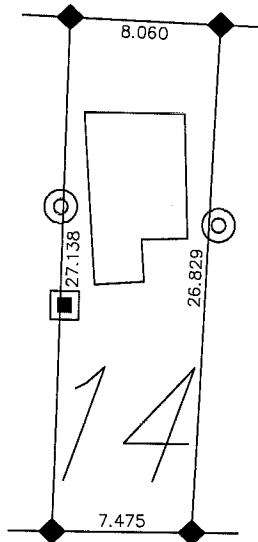

AREA	
sq. m.	= 209.51
sq. ft.	= 2255.2

SCALE  
1:400

PREPARED BY:  
  
**Webb Surveys**  
 07-1622cs B.J.F.

# POPLAR BEACH



## R.V. RESORT

WAKAW LAKE, SASK.

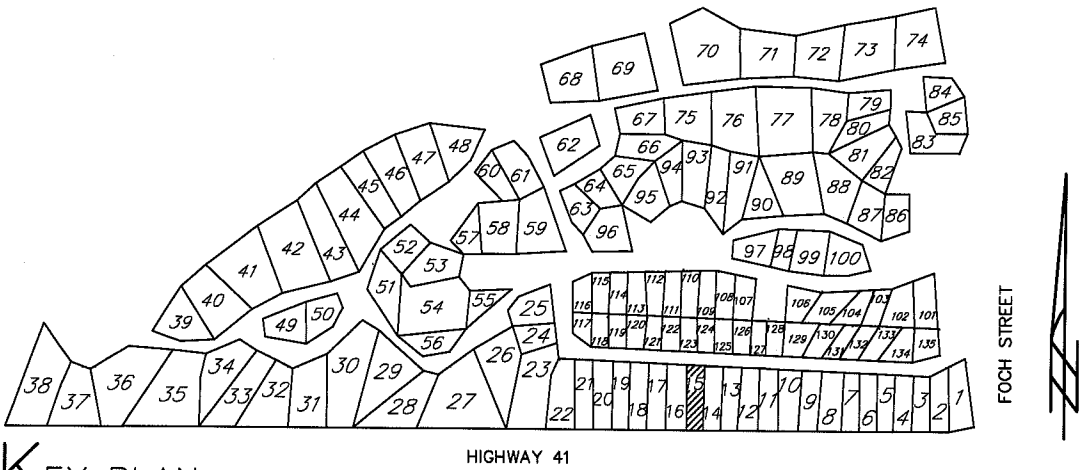

### LEGEND

- Light Pole
- Septic Tank Lid
- ⊗ Water Valve
- Electrical Outlet
- Telephone Pedestal
- ◆ 0.013 X 0.450 m small iron post

## KEY PLAN

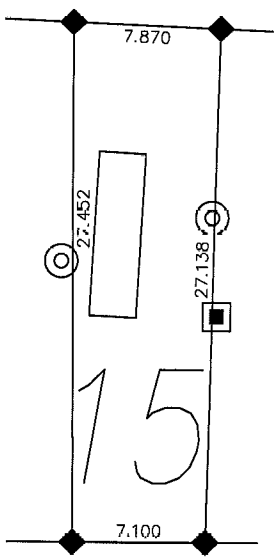

**AREA**  
 sq. m. = 204.23  
 sq. ft. = 2198.3

SCALE  
 1: 400

PREPARED BY:  
  
 07-1622cs B.J.F.

# POPLAR BEACH

## R.V. RESORT

WAKAW LAKE, SASK.

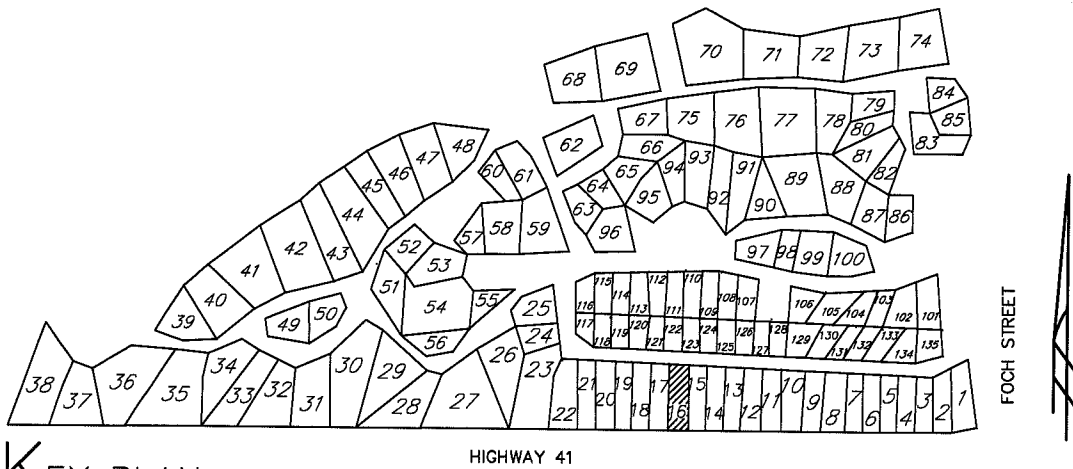

### LEGEND

- Light Pole
- Septic Tank Lid
- ⊗ Water Valve
- Electrical Outlet
- Telephone Pedestal
- ◆ 0.013 X 0.450 m small iron post

## KEY PLAN

HIGHWAY 41

FOCH STREET

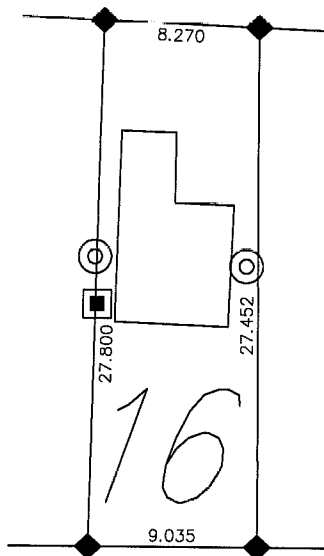

**AREA**  
 sq. m. = 238.95  
 sq. ft. = 2572.1

SCALE  
 1: 400

PREPARED BY:  
  
**Webb Surveys**  
 07-1622cs B/J



# POPLAR BEACH



## R.V. RESORT

WAKAW LAKE, SASK.

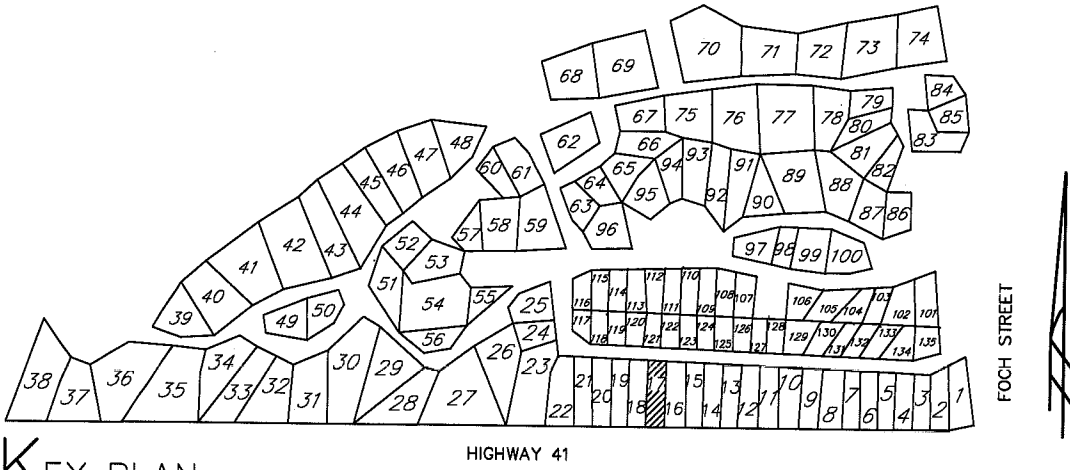

KEY PLAN

**LEGEND**

- Light Pole
- Septic Tank Lid
- ⊗ Water Valve
- Electrical Outlet
- Telephone Pedestal
- ◆ 0.013 X 0.450 m small iron post

HIGHWAY 41

FOCH STREET

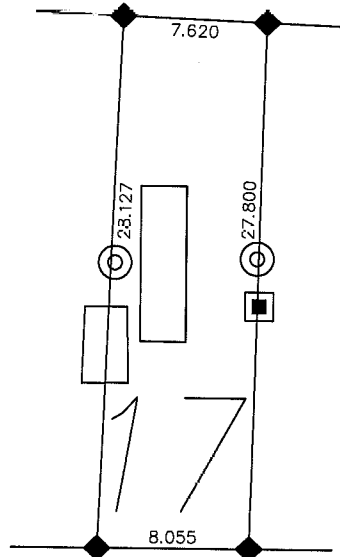

**AREA**  
 sq. m. = 219.09  
 sq. ft. = 2358.3

SCALE  
 1: 400

PREPARED BY:  
  
**Webb Surveys**

07-1622cs BJB

# POPLAR BEACH

## R.V. RESORT

WAKAW LAKE, SASK.

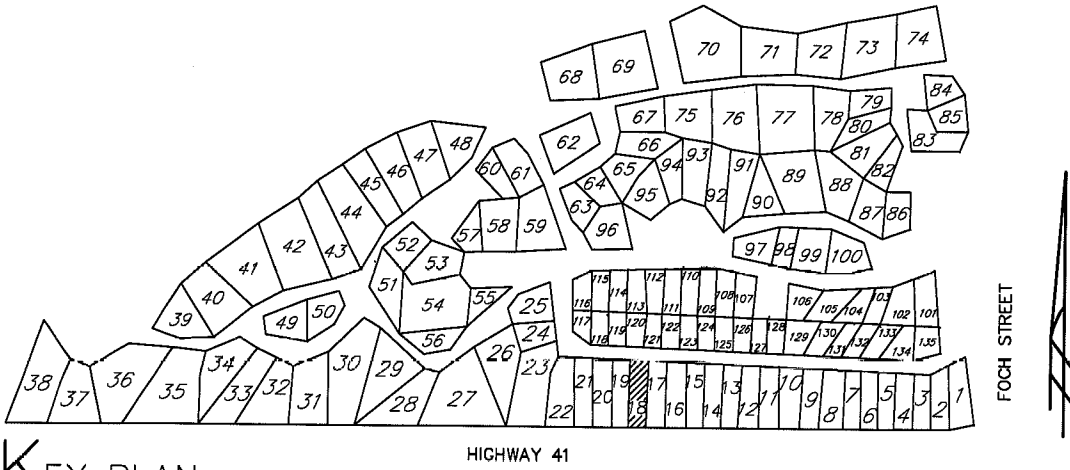

KEY PLAN

HIGHWAY 41

FOCH STREET

**LEGEND**

- Light Pole
- Septic Tank Lid
- ⊗ Water Valve
- Electrical Outlet
- Telephone Pedestal
- ◆ 0.013 X 0.450 m small iron post

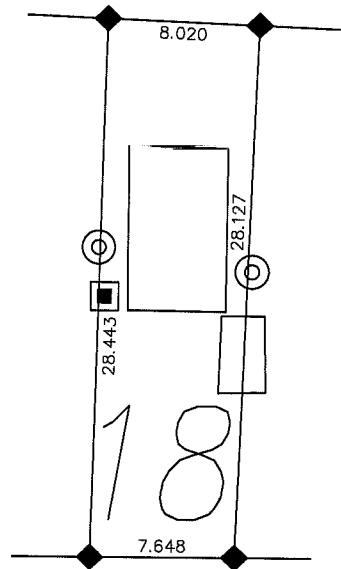

**AREA**  
 sq. m. = 221.52  
 sq. ft. = 2384.4

SCALE  
 1: 400

PREPARED BY:  
  
**Webb Surveys**  
 07-1622cs B/J

# POPLAR BEACH

## R.V. RESORT

WAKAW LAKE, SASK.

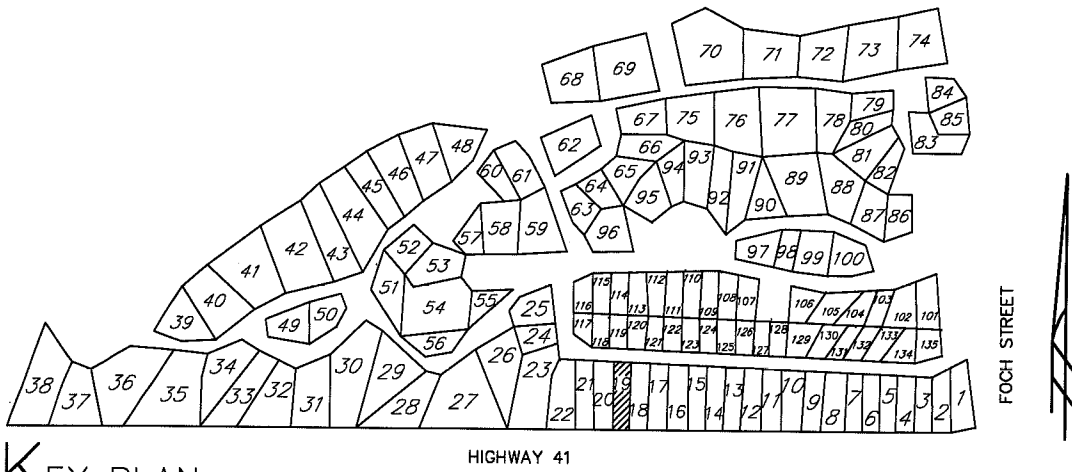

KEY PLAN

HIGHWAY 41

FOCH STREET

**LEGEND**

- Light Pole
- Septic Tank Lid
- ⊗ Water Valve
- Electrical Outlet
- Telephone Pedestal
- ◆ 0.013 X 0.450 m small iron post

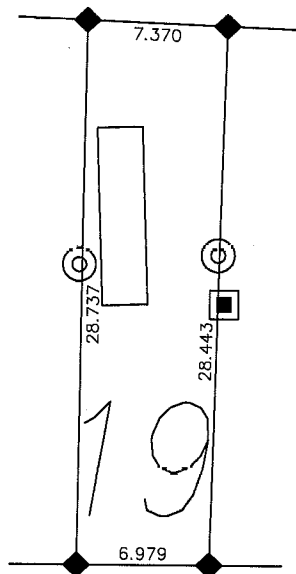

**AREA**  
 sq. m. = 205.08  
 sq. ft. = 2207.4

SCALE  
 1: 400

PREPARED BY:  
  
**Webb Surveys**  
 07-1622cs B/J

# POPLAR BEACH



## R. V. RESORT

WAKAW LAKE, SASK.

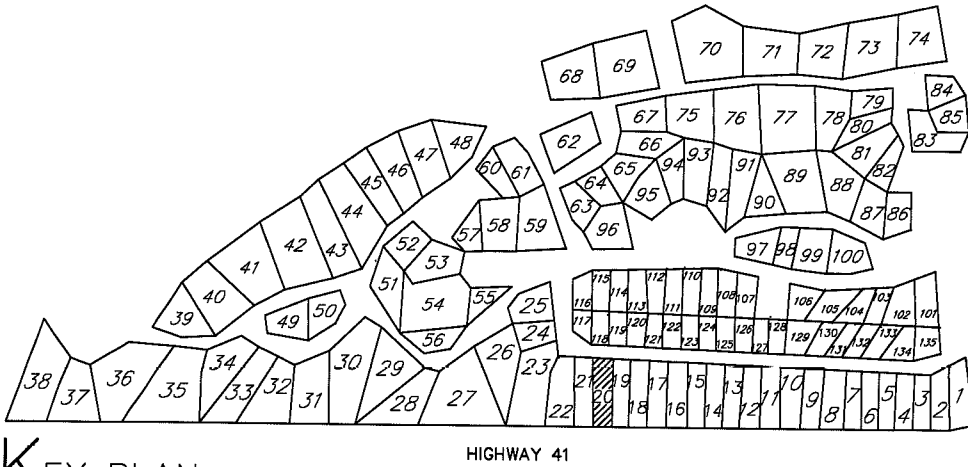

KEY PLAN

### LEGEND

- Light Pole
- Septic Tank Lid
- ⊗ Water Valve
- Electrical Outlet
- Telephone Pedestal
- ◆ 0.013 X 0.450 m small iron post

HIGHWAY 41

FOCH STREET

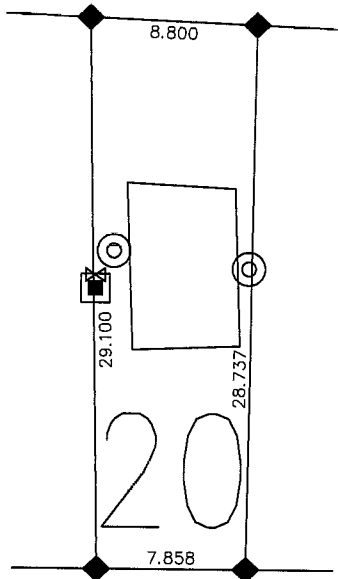

AREA	
sq. m.	= 240.71
sq. ft.	= 2591.0

SCALE  
1:400

PREPARED BY:  
  
**Webb Surveys**  
 07-1622cs B/JF

# POPLAR BEACH



## R.V. RESORT

WAKAW LAKE, SASK.

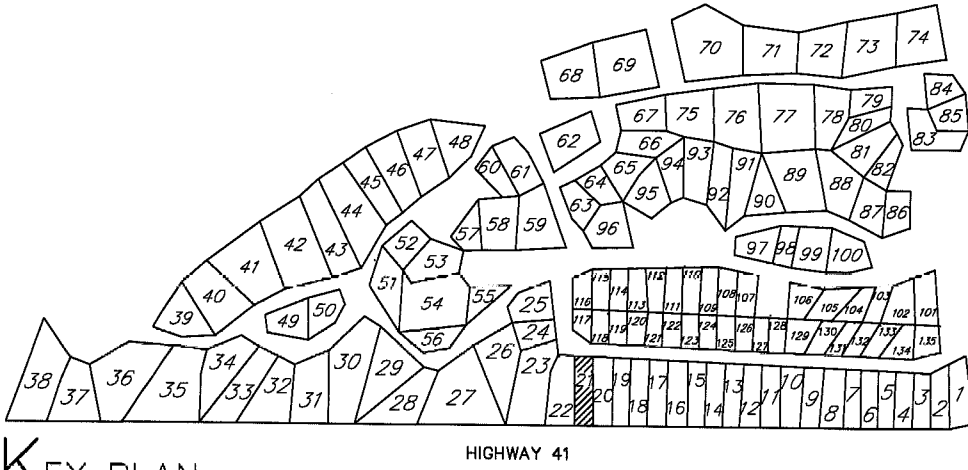

### LEGEND

- Light Pole
- Septic Tank Lid
- ⊗ Water Valve
- Electrical Outlet
- Telephone Pedestal
- ◆ 0.013 X 0.450 m small iron post

### KEY PLAN

HIGHWAY 41

FOCH STREET

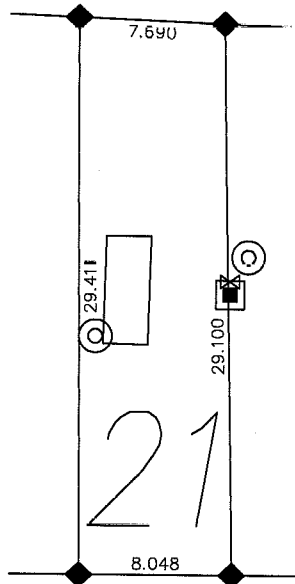

AREA	
sq. m.	= 230.04
sq. ft.	= 2476.2

SCALE  
1:400

PREPARED BY:  
  
**Webb Surveys**  
 07-1622cs B/JF

# POPLAR BEACH



## R.V. RESORT

WAKAW LAKE, SASK.

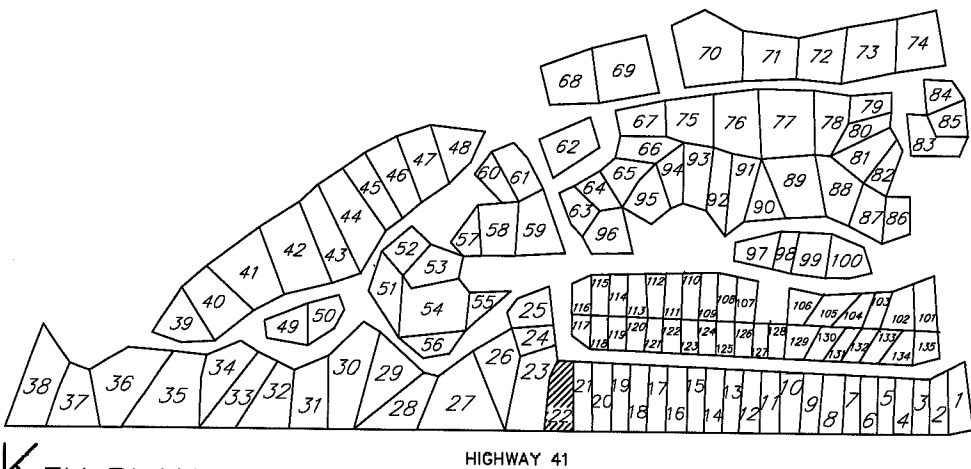

### LEGEND

- Light Pole
- Septic Tank Lid
- ⊗ Water Valve
- Electrical Outlet
- Telephone Pedestal
- ◆ 0.013 X 0.450 m small iron post

## KEY PLAN

HIGHWAY 41

FOCH STREET

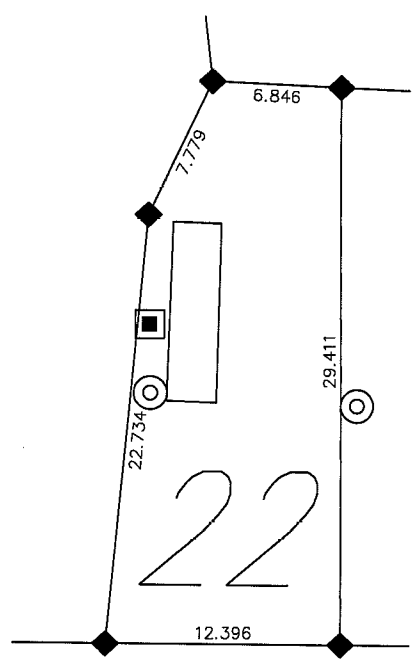

**AREA**  
 sq. m. = 314.19  
 sq. ft. = 3382.0

SCALE  
 1: 400

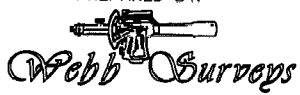
PREPARED BY:  
  
 07-1622cs BJF

# POPLAR BEACH



## R.V. RESORT

WAKAW LAKE, SASK.

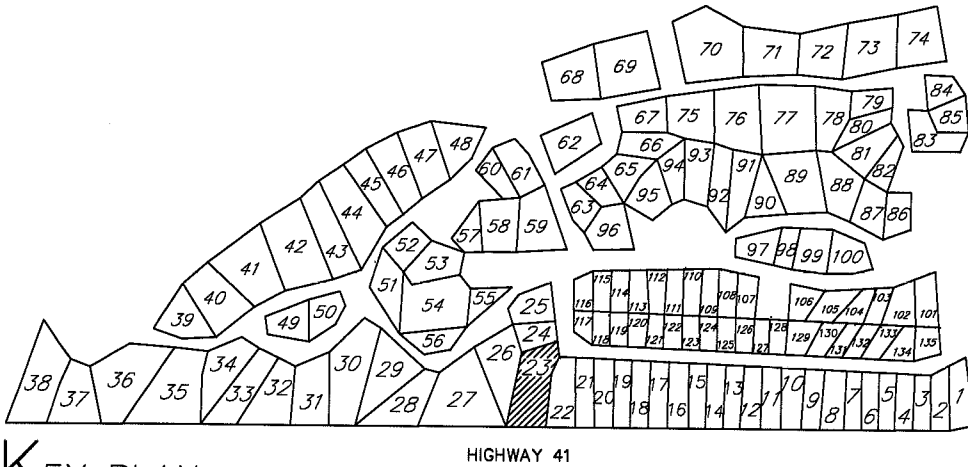

KEY PLAN

**LEGEND**

- Light Pole
- Septic Tank Lid
- ⊗ Water Valve
- Electrical Outlet
- Ⓟ Telephone Pedestal
- ◆ 0.013 X 0.450 m small iron post

HIGHWAY 41

FOCH STREET

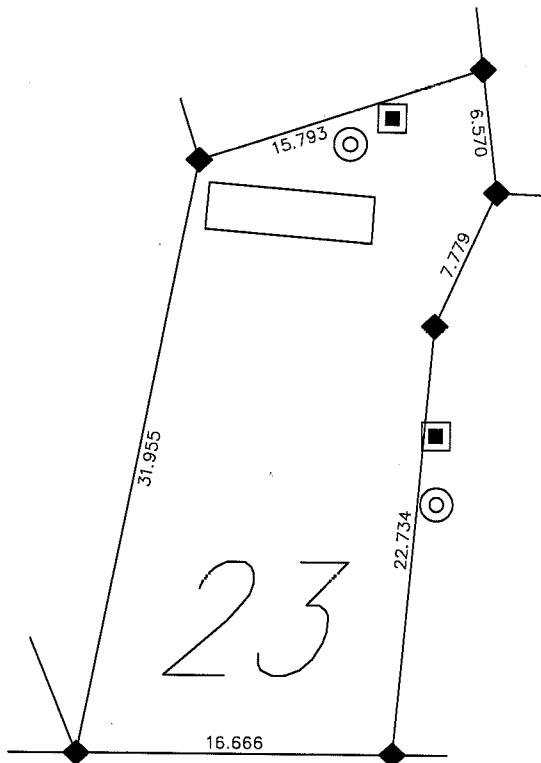

**AREA**  
 sq. m. = 521.91  
 sq. ft. = 5617.8

SCALE  
1:400

PREPARED BY:  
  
**Webb Surveys**  
 07-1622cs BJJ

# POPLAR BEACH



## R. V. RESORT

WAKAW LAKE, SASK.

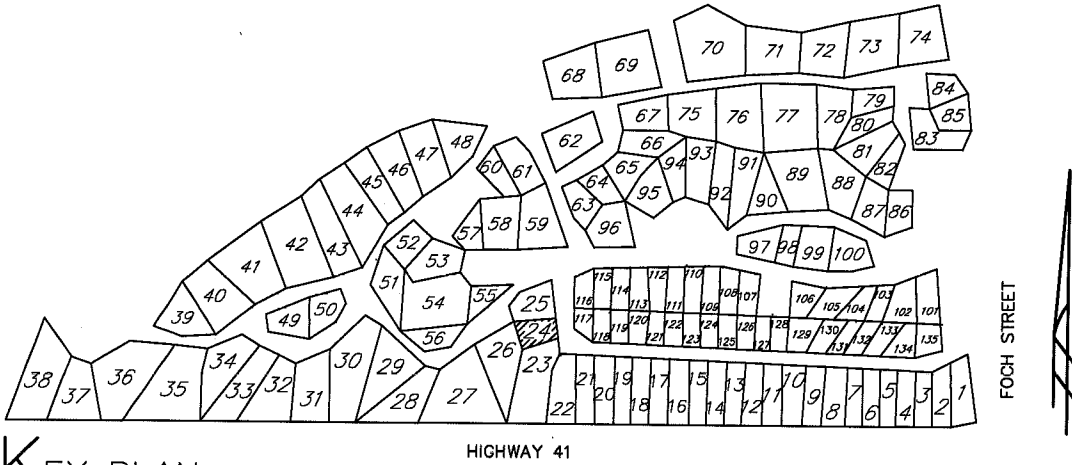

### LEGEND

- Light Pole
- Septic Tank Lid
- ⊗ Water Valve
- Electrical Outlet
- Telephone Pedestal
- ◆ 0.013 X 0.450 m small iron post

### KEY PLAN

HIGHWAY 41

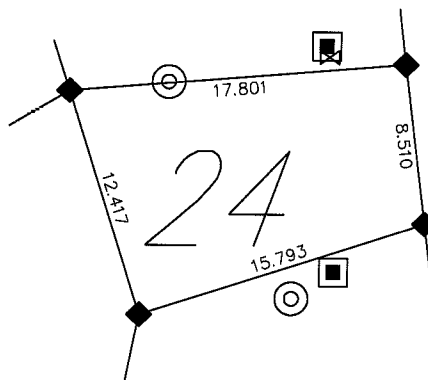

AREA	
sq. m.	= 173.74
sq. ft.	= 1870.1

SCALE  
1: 400

PREPARED BY:  
  
**Webb Surveys**  
 07-1622cs B.J.F.



# POPLAR BEACH



## R. V. RESORT

WAKAW LAKE, SASK.

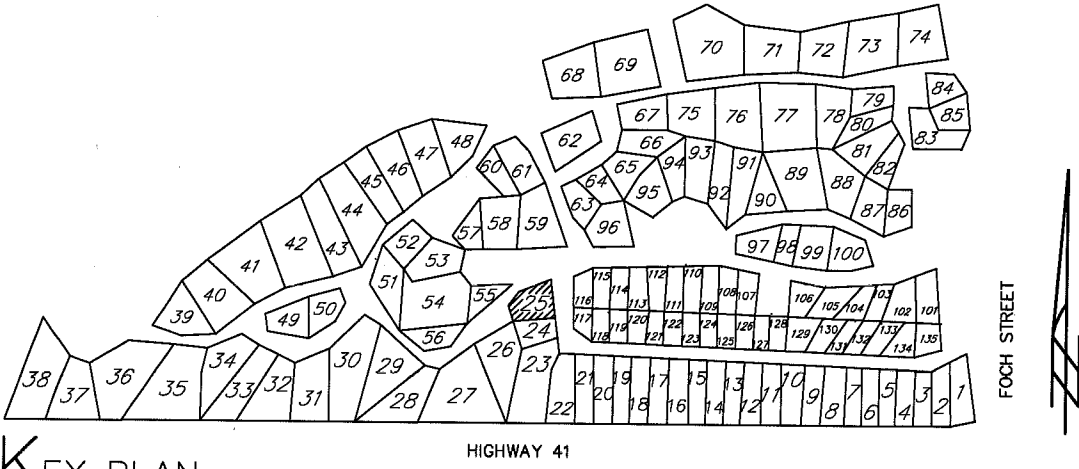

### LEGEND

- Light Pole
- Septic Tank Lid
- ⊗ Water Valve
- Electrical Outlet
- Ⓟ Telephone Pedestal
- ◆ 0.013 X 0.450 m small iron post

### KEY PLAN

HIGHWAY 41

FOCH STREET

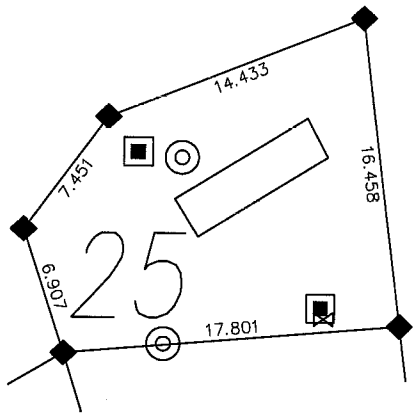

<b>AREA</b>	
sq. m. =	245.54
sq. ft. =	2643.0

SCALE  
1: 400

PREPARED BY:  
  
**Webb Surveys**  
 07-1622cs B.J.F.

# POPLAR BEACH



## R. V. RESORT

WAKAW LAKE, SASK.

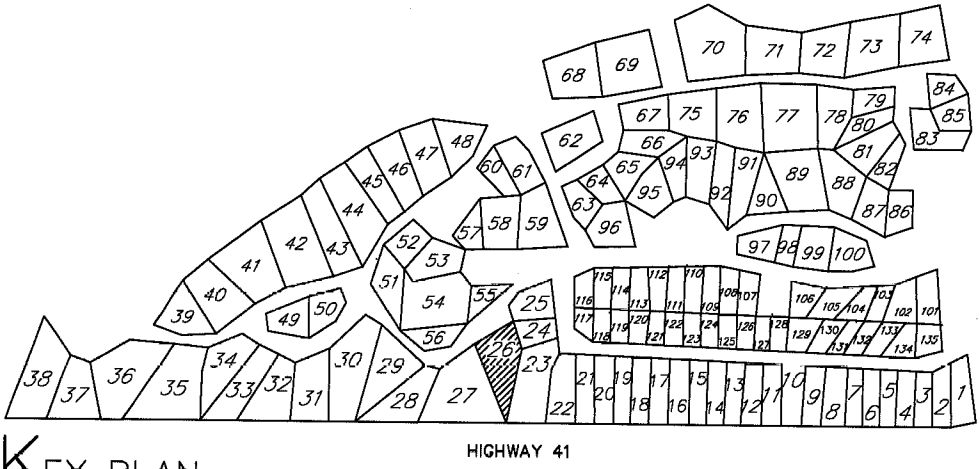

- LEGEND**
- Light Pole
  - Septic Tank Lid
  - ⊗ Water Valve
  - Electrical Outlet
  - Telephone Pedestal
  - ◆ 0.013 X 0.450 m small iron post

### KEY PLAN

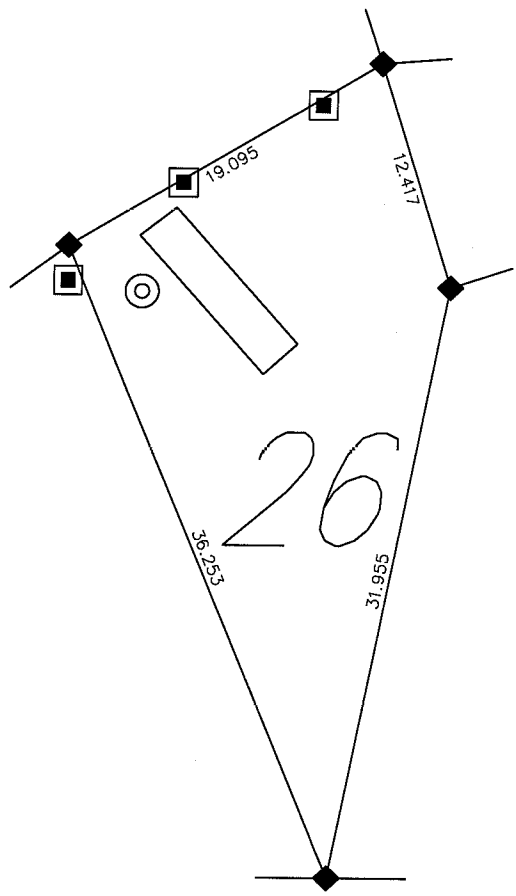

**AREA**  
 sq. m. = 438.48  
 sq. ft. = 4719.8

SCALE  
 1: 400

PREPARED BY:  
  
**Webb Surveys**  
 07-1622cs B.J.F.

# POPLAR BEACH



## R. V. RESORT

WAKAW LAKE, SASK.

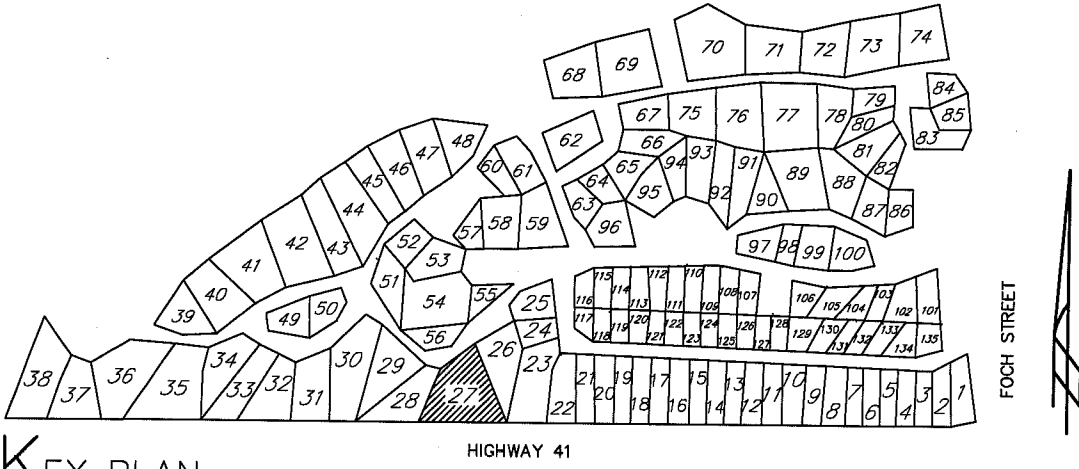

### LEGEND

- Light Pole
- Septic Tank Lid
- ⊗ Water Valve
- Electrical Outlet
- Ⓟ Telephone Pedestal
- ◆ 0.013 X 0.450 m small iron post

### KEY PLAN

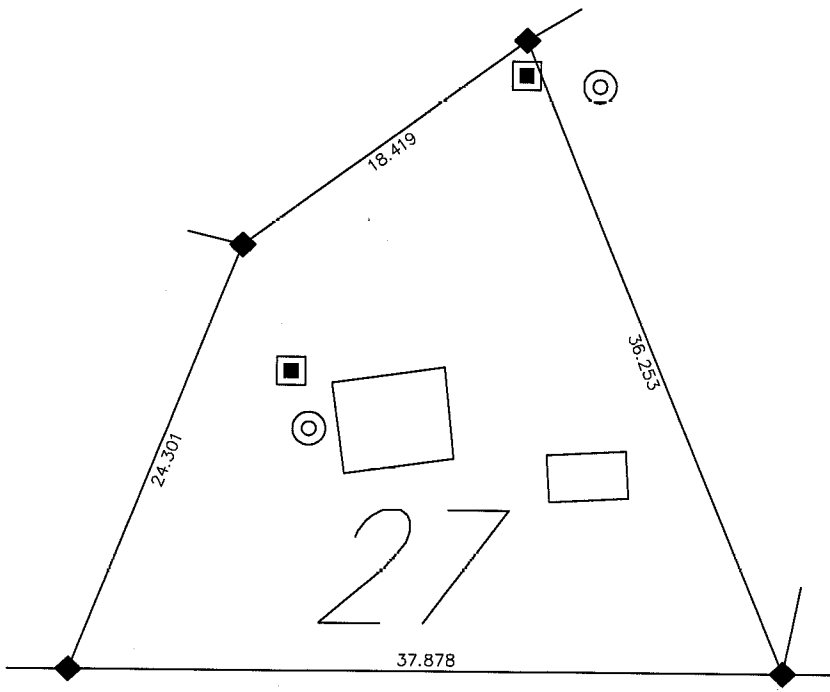

**AREA**  
 sq. m. = 751.32  
 sq. ft. = 8087.1

SCALE  
 1: 400

PREPARED BY:  
  
**Webb Surveys**  
 07-1622cs B.J.F.

# POPLAR BEACH



## R.V. RESORT

WAKAW LAKE, SASK.

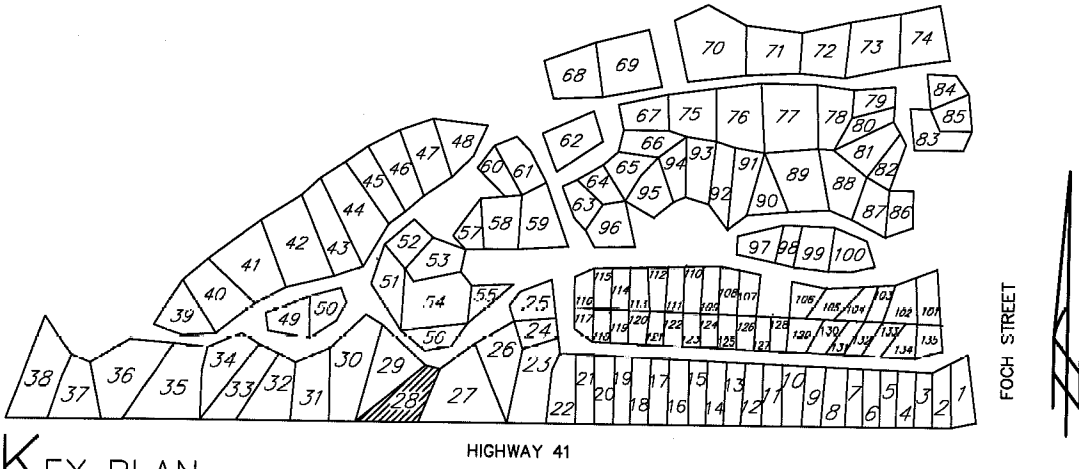

- LEGEND**
- Light Pole
  - ⊙ Septic Tank Lid
  - ⊗ Water Valve
  - Electrical Outlet
  - Ⓟ Telephone Pedestal
  - ◆ 0.013 X 0.450 m small iron post

KEY PLAN

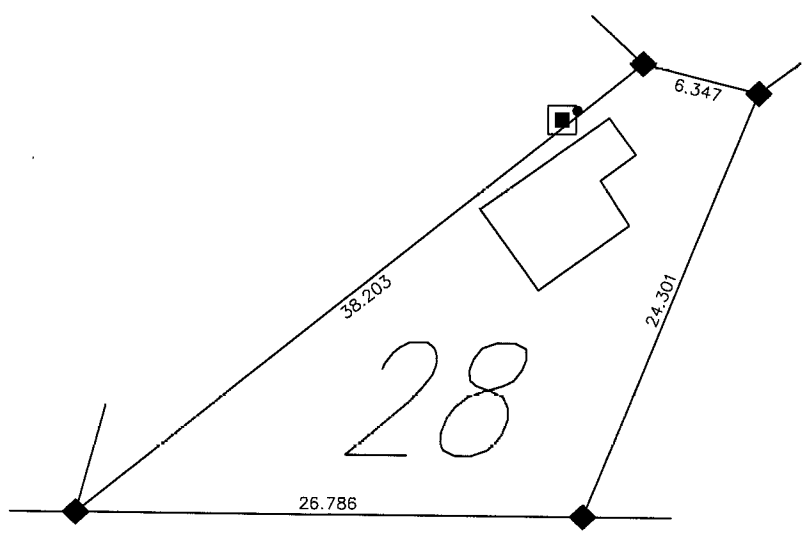

**AREA**  
 sq. m. = 398.19  
 sq. ft. = 4286.1

SCALE  
 1:400

PREPARED BY:  
  
**Webb Surveys**  
 07-1622cs BJF

# POPLAR BEACH



## R.V. RESORT

WAKAW LAKE, SASK.

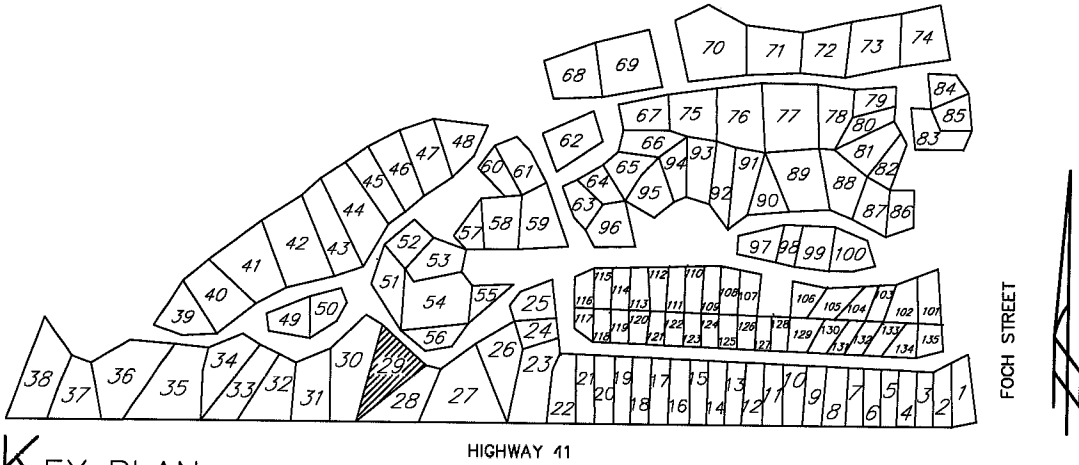

- LEGEND**
- Light Pole
  - Septic Tank Lid
  - ⊠ Water Valve
  - Electrical Outlet
  - Telephone Pedestal
  - ◆ 0.013 X 0.450 m small iron post

### KEY PLAN

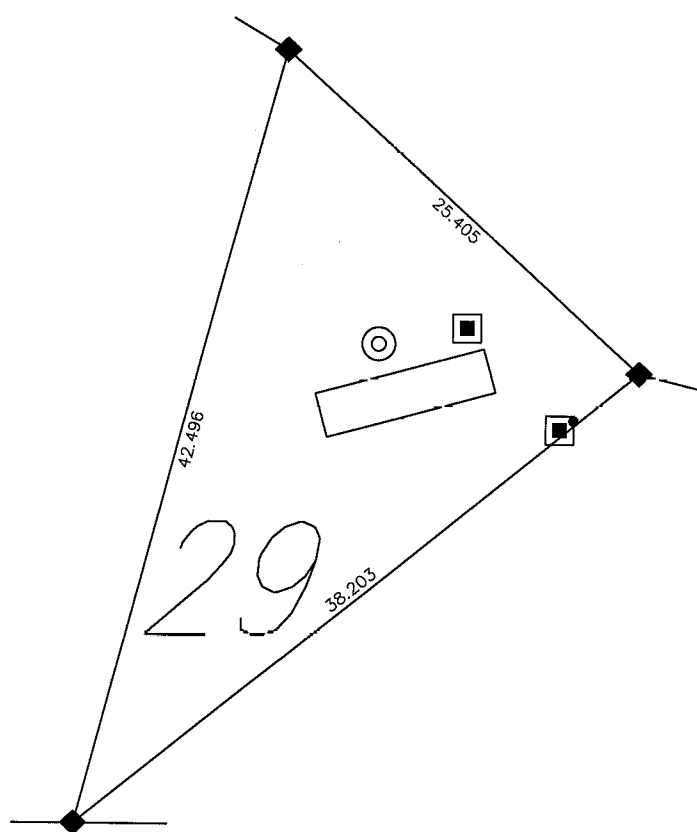

**AREA**  
 sq. m. = 479.49  
 sq. ft. = 5161.2

SCALE  
 1:400

PREPARED BY:  
  
**Webb Surveys**  
 07-1622cs B/JF

# POPLAR BEACH



## R. V. RESORT

WAKAW LAKE, SASK.

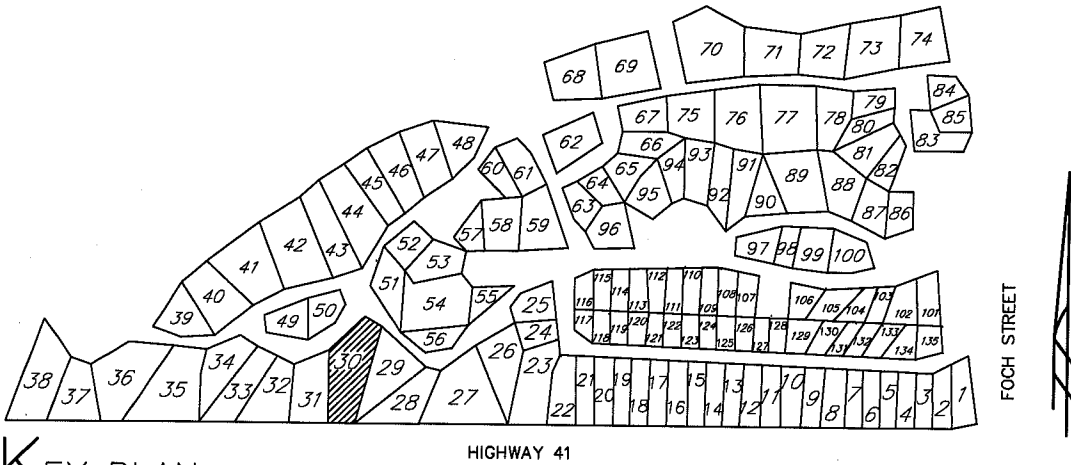

### LEGEND

- Light Pole
- Septic Tank Lid
- ⊗ Water Valve
- Electrical Outlet
- Telephone Pedestal
- ◆ 0.013 X 0.450 m small iron post

### KEY PLAN

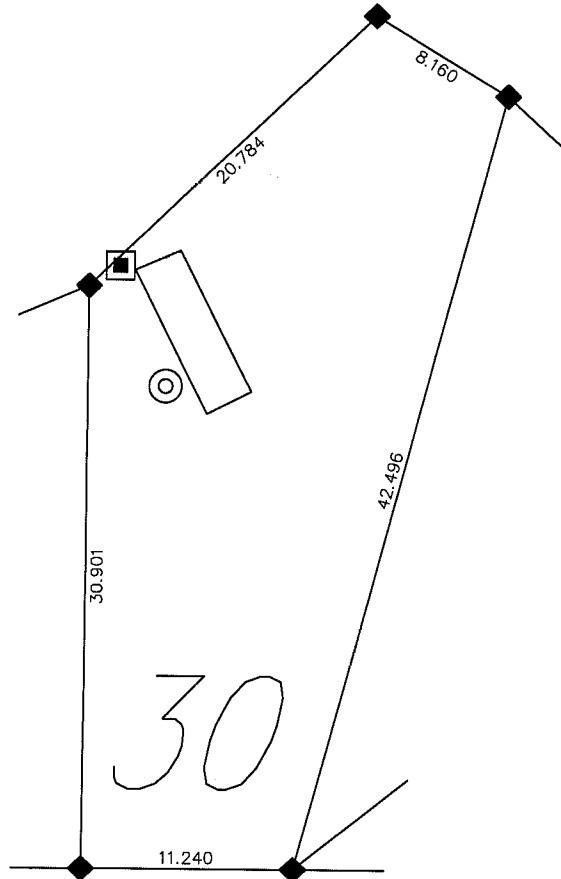

**AREA**  
 sq. m. = 652.01  
 sq. ft. = 7018.2

SCALE  
 1:400

PREPARED BY:  
  
**Webb Surveys**  
 07-1622cs B.J.F.

# POPLAR BEACH



## R.V. RESORT

WAKAW LAKE, SASK.

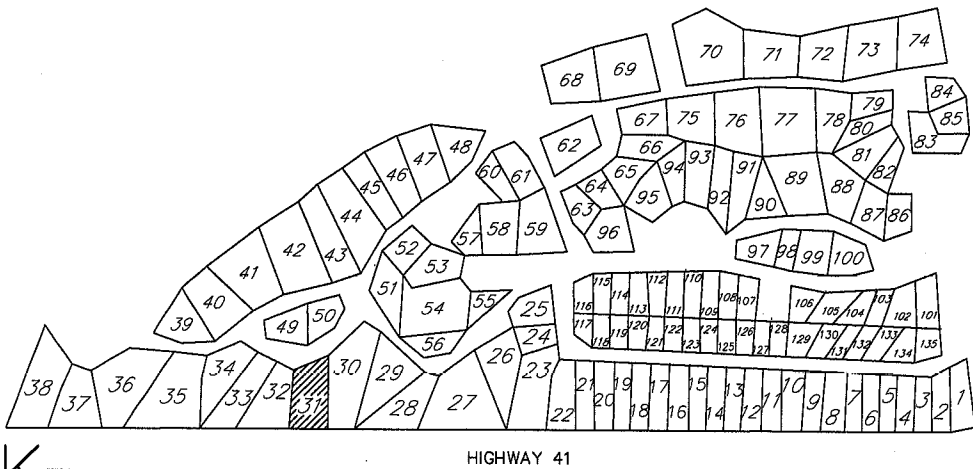

### LEGEND

- Light Pole
- Septic Tank Lid
- ⊗ Water Valve
- Electrical Outlet
- Ⓟ Telephone Pedestal
- ◆ 0.013 X 0.450 m small iron post

### KEY PLAN

HIGHWAY 41

FOCH STREET

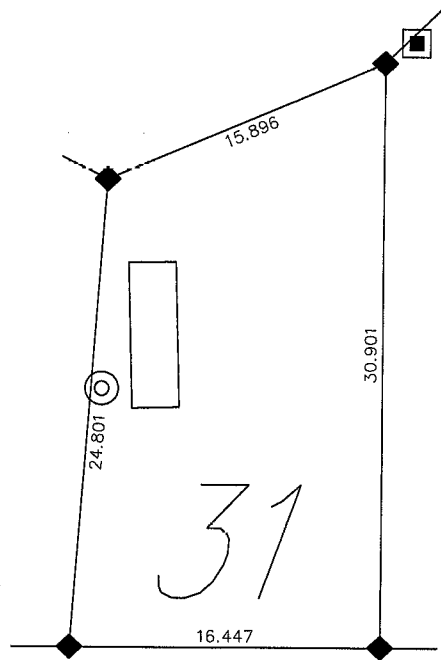

**AREA**  
 sq. m. = 429.35  
 sq. ft. = 4621.5

SCALE  
 1: 400

PREPARED BY:  
  
**Webb Surveys**  
 07-1622cs B/J

# POPLAR BEACH



## R.V. RESORT

WAKAW LAKE, SASK.

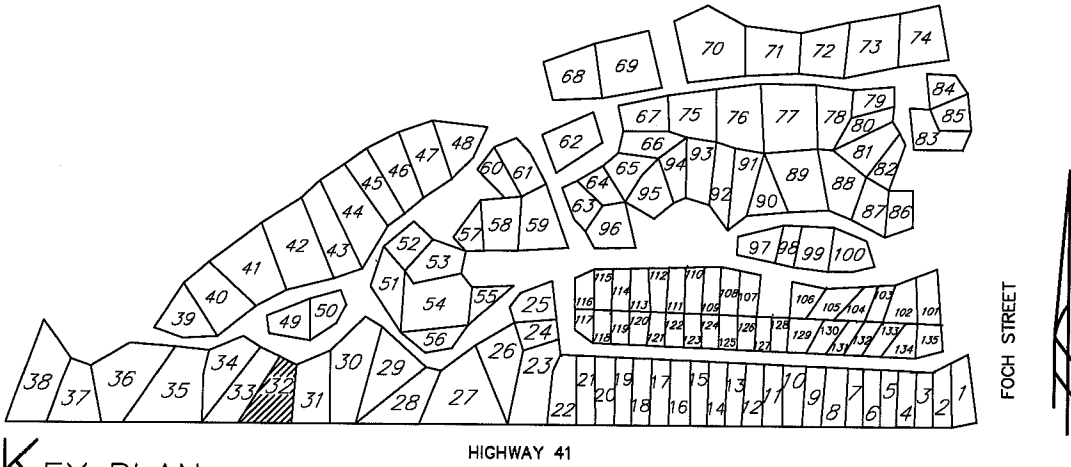

### KEY PLAN

#### LEGEND

- Light Pole
- ⊙ Septic Tank Lid
- ⊠ Water Valve
- Electrical Outlet
- Ⓟ Telephone Pedestal
- ◆ 0.013 X 0.450 m small iron post

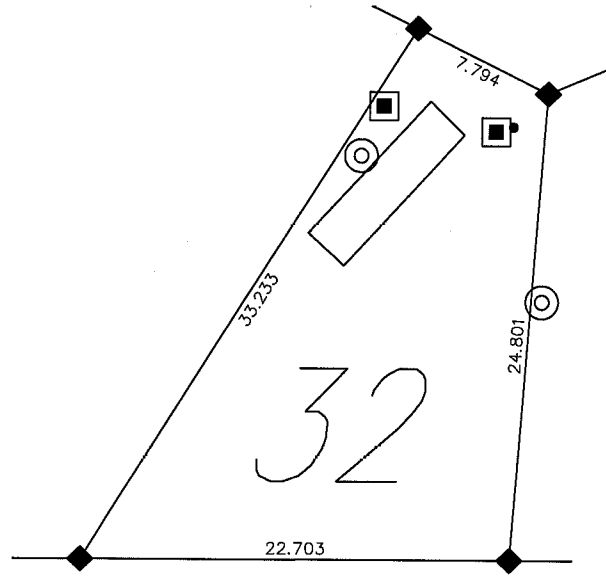

AREA	
sq. m.	= 409.56
sq. ft.	= 4408.5

SCALE  
1: 400

PREPARED BY:  
  
**Webb Surveys**  
 07-162266 B/JF



# POPLAR BEACH



## R.V. RESORT

WAKAW LAKE, SASK.

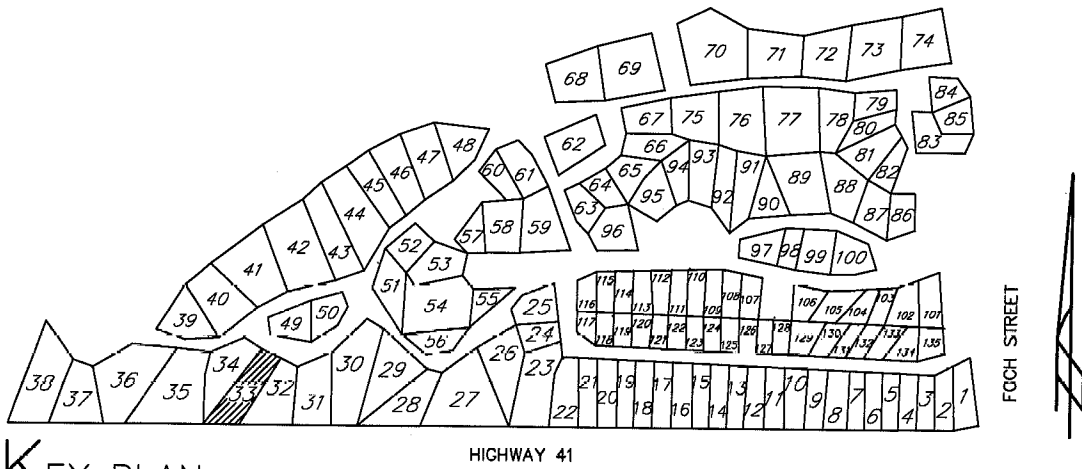

### LEGEND

- Light Pole
- ⊙ Septic Tank Lid
- ⊗ Water Valve
- Electrical Outlet
- Ⓟ Telephone Pedestal
- ◆ 0.013 X 0.450 m small iron post

### KEY PLAN

HIGHWAY 41

FOCH STREET

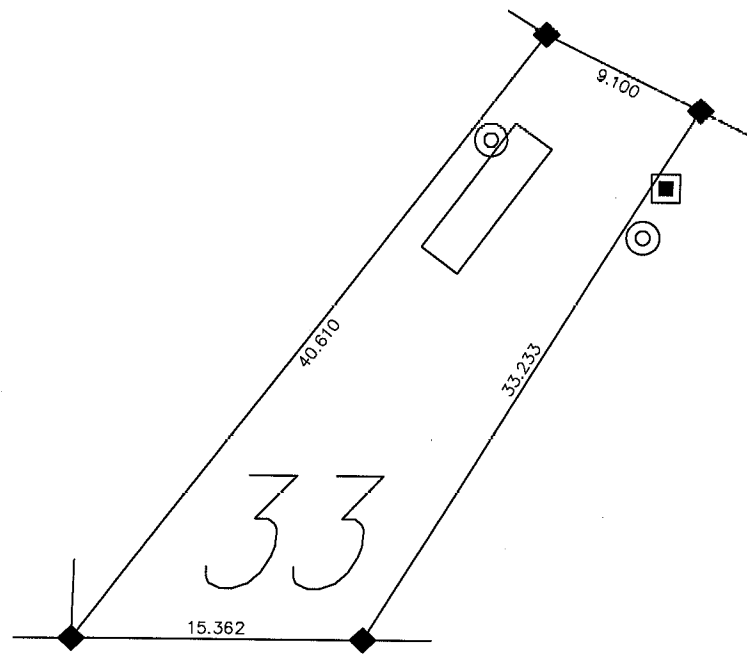

**AREA**  
 sq. m. = 397.37  
 sq. ft. = 4277.3

SCALE  
 1:400

PREPARED BY:  
  
**Webb Surveys**  
 07-1622cs B.J.F.

# POPLAR BEACH



## R.V. RESORT

WAKAW LAKE, SASK.

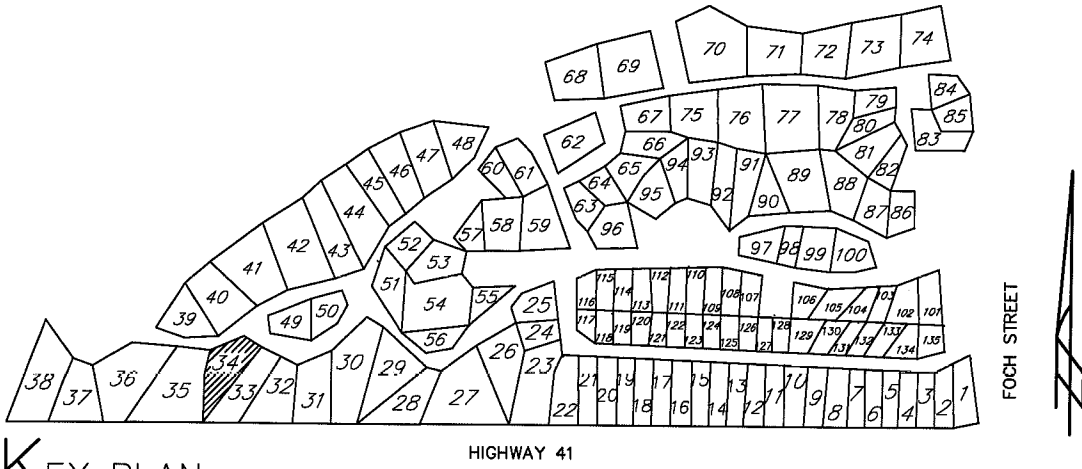

### LEGEND

- Light Pole
- Septic Tank Lid
- ⊗ Water Valve
- Electrical Outlet
- Ⓟ Telephone Pedestal
- ◆ 0.013 X 0.450 m small iron post

### KEY PLAN

HIGHWAY 41

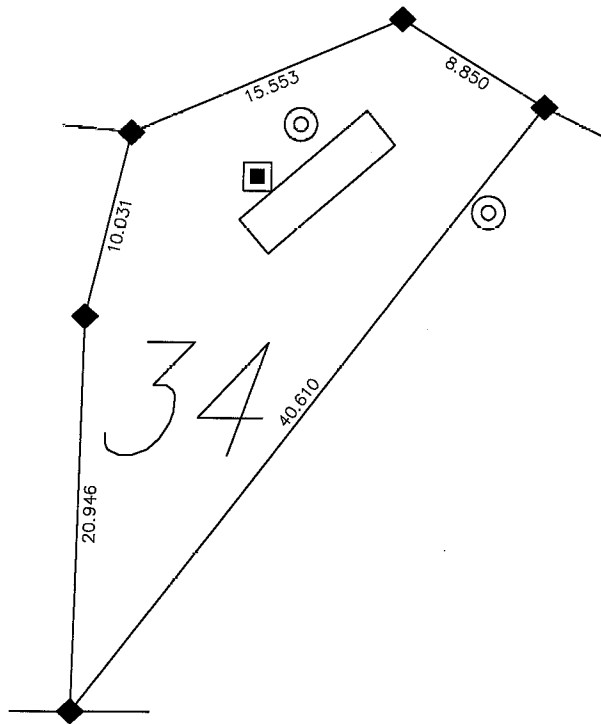

AREA	
sq. m.	= 410.93
sq. ft.	= 4423.2

SCALE  
1:400

PREPARED BY:  
  
**Webb Surveys**  
 07-1622cs B/JF

# POPLAR BEACH



## R.V. RESORT

WAKAW LAKE, SASK.

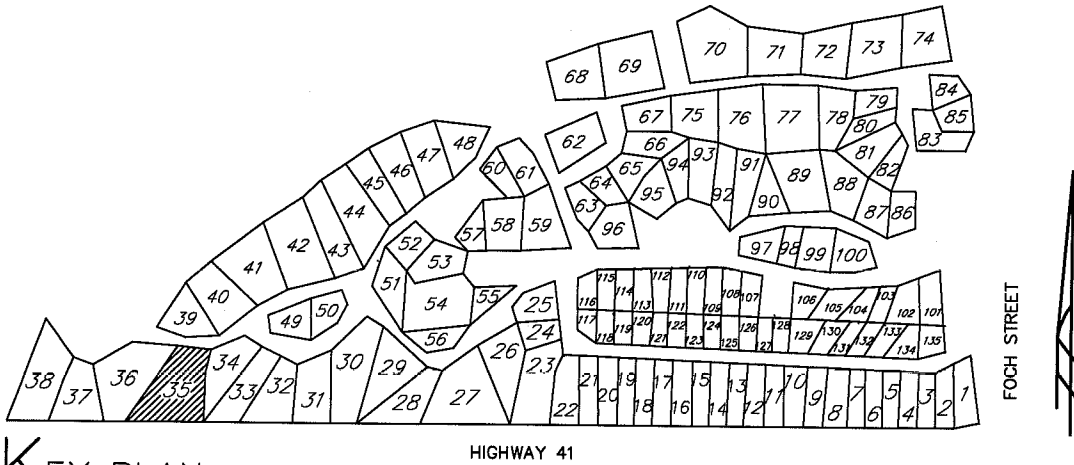

### KEY PLAN

#### LEGEND

- Light Pole
- ⊙ Septic Tank Lid
- ⊠ Water Valve
- Electrical Outlet
- Ⓟ Telephone Pedestal
- ◆ 0.013 X 0.450 m small iron post

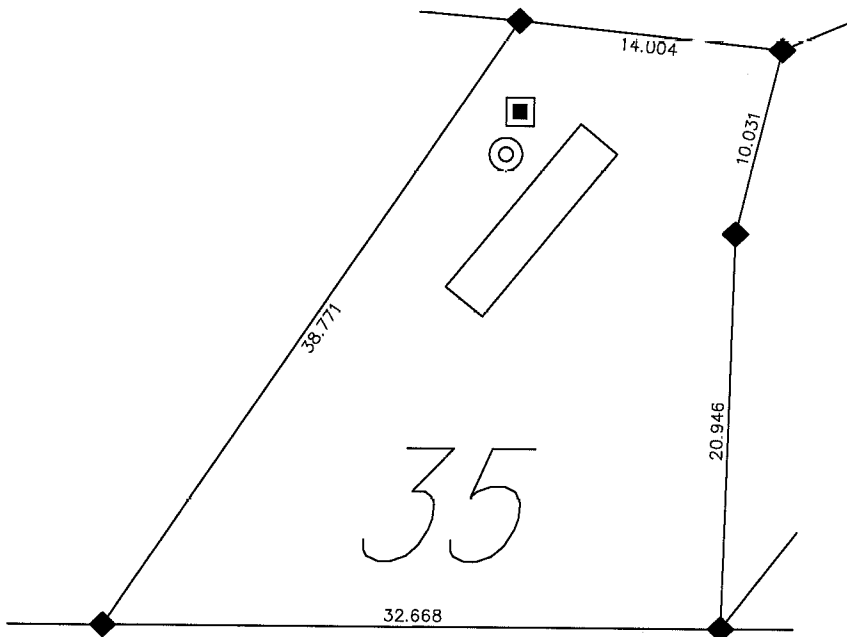

AREA	
sq. m.	= 719.20
sq. ft.	= 7741.4

SCALE  
1:400

PREPARED BY:  
  
**Webb Surveys**  
 07-1622cs B.J.F.

# POPLAR BEACH



## R.V. RESORT

WAKAW LAKE, SASK.

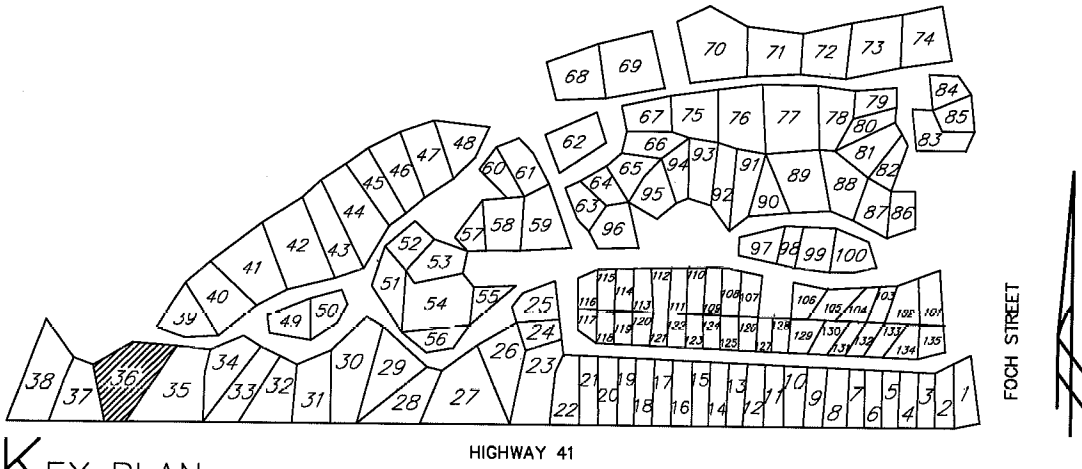

### LEGEND

- Light Pole
- Septic Tank Lid
- ⊗ Water Valve
- Electrical Outlet
- Ⓟ Telephone Pedestal
- ◆ 0.013 X 0.450 m small iron post

### KEY PLAN

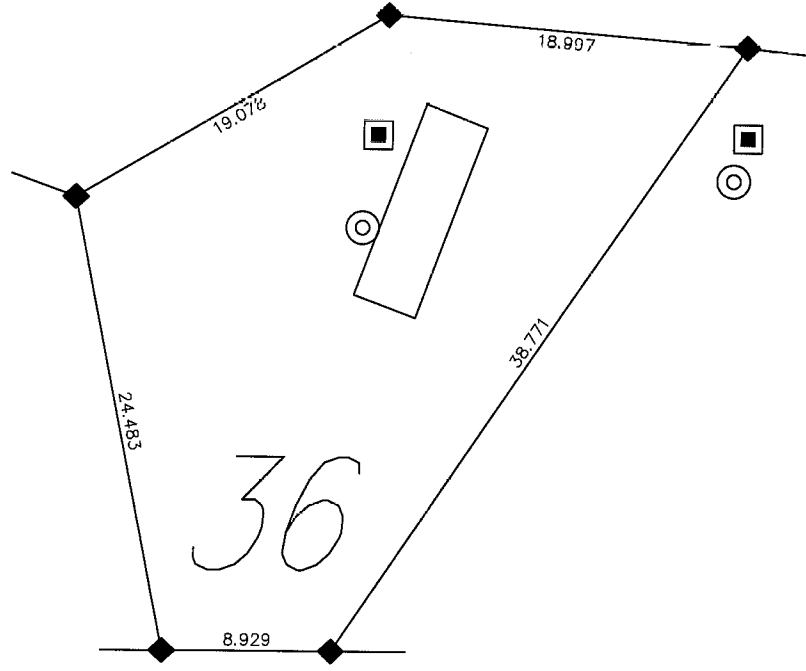

**AREA**  
 sq. m. = 692.38  
 sq. ft. = 7452.7

SCALE  
 1:400

PREPARED BY:  
  
**Webb Surveys**  
 07-1622cs B.J.F.

# POPLAR BEACH

## R.V. RESORT

WAKAW LAKE, SASK.

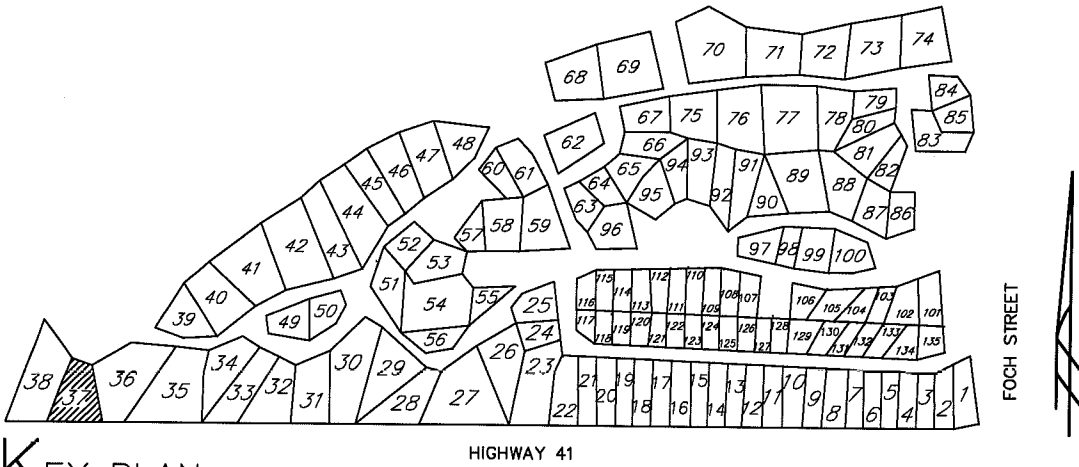

- LEGEND**
- Light Pole
  - ⊙ Septic Tank Lid
  - ⊗ Water Valve
  - Electrical Outlet
  - Ⓟ Telephone Pedestal
  - ◆ 0.013 X 0.450 m small iron post

KEY PLAN

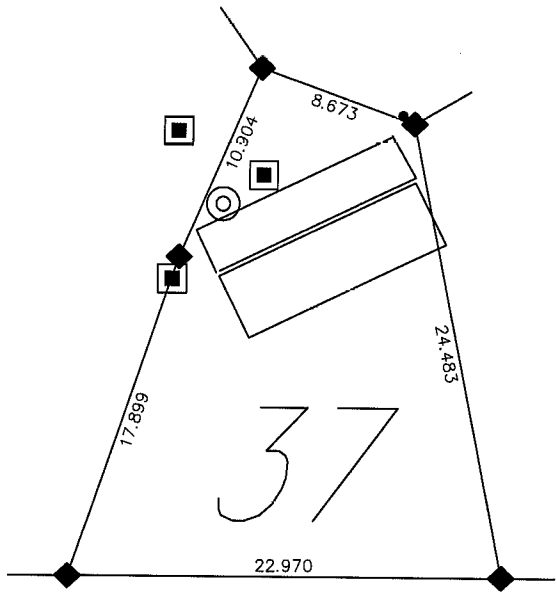

**AREA**  
 sq. m. = 408.26  
 sq. ft. = 4394.5

SCALE  
 1: 400

PREPARED BY:  
  
**Webb Surveys**  
 07-1622cs B.J.F.

# POPLAR BEACH



## R.V. RESORT

WAKAW LAKE, SASK.

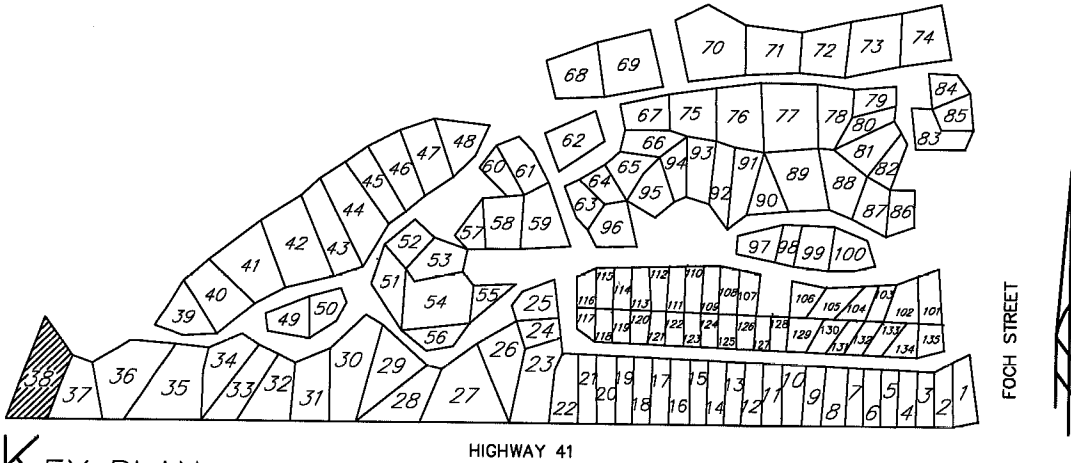

KEY PLAN

### LEGEND

- Light Pole
- ⊙ Septic Tank Lid
- ⊗ Water Valve
- Electrical Outlet
- Ⓟ Telephone Pedestal
- ◆ 0.013 X 0.450 m small iron post

HIGHWAY 41

FOCH STREET

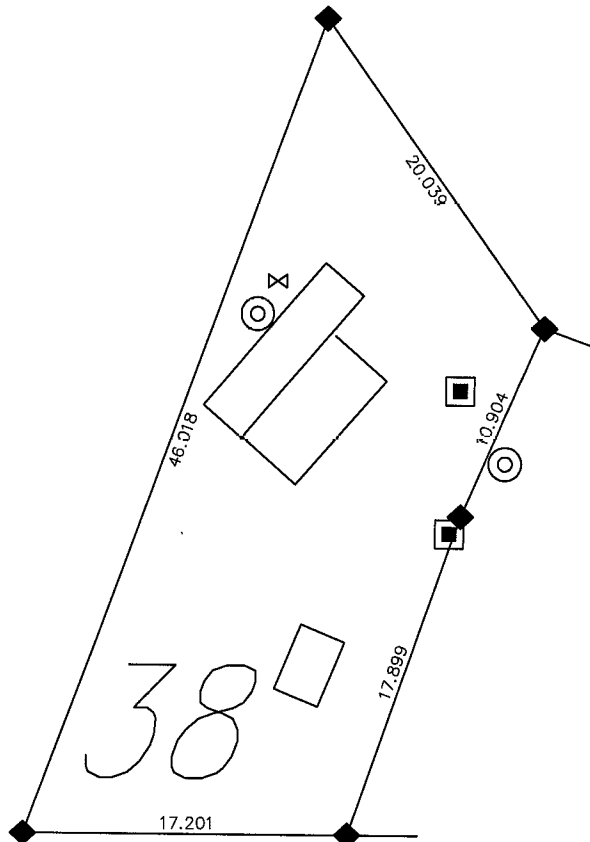

AREA	
sq. m.	= 603.69
sq. ft.	= 6498.0

SCALE  
1:400

PREPARED BY:

*Peck Surveys*

07-1622cs B.J.F.

# POPLAR BEACH



## R.V. RESORT

WAKAW LAKE, SASK.

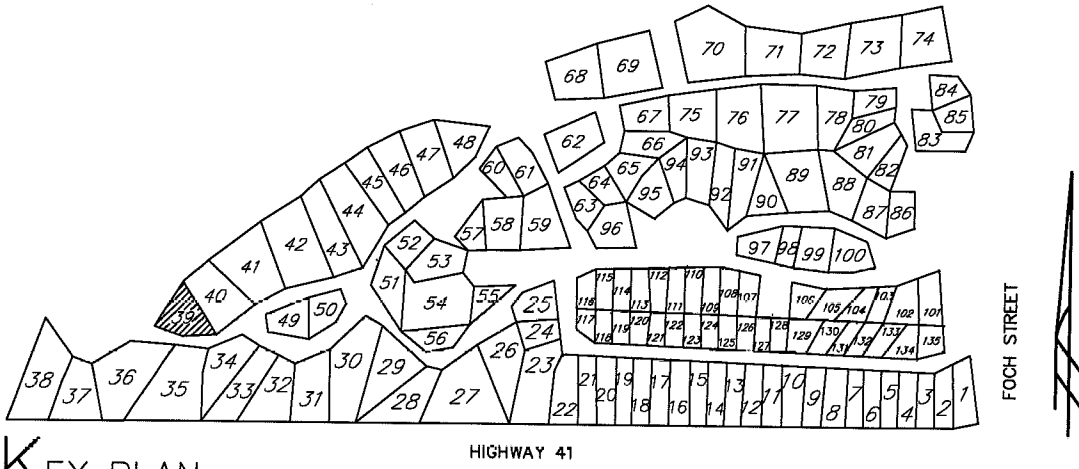

### LEGEND

- Light Pole
- ⊙ Septic Tank Lid
- ⊗ Water Valve
- Electrical Outlet
- Ⓟ Telephone Pedestal
- ◆ 0.013 X 0.450 m small iron post

### KEY PLAN

HIGHWAY 41

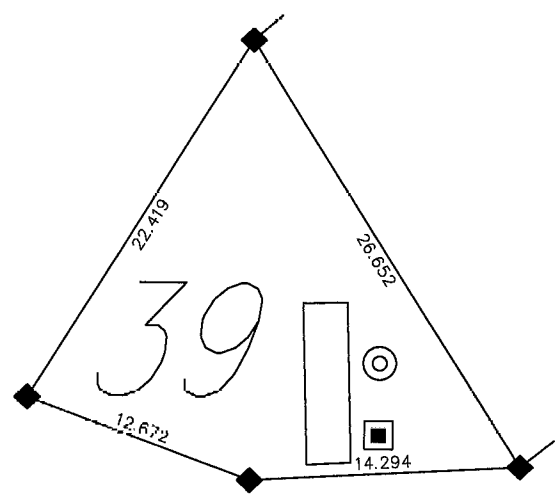

AREA	
sq. m.	= 305.34
sq. ft.	= 3286.7

SCALE  
1:400

PREPARED BY:  
  
**Pebb Surveys**  
 07-1622cs B.J.F.

# POPLAR BEACH



## R.V. RESORT

WAKAW LAKE, SASK.

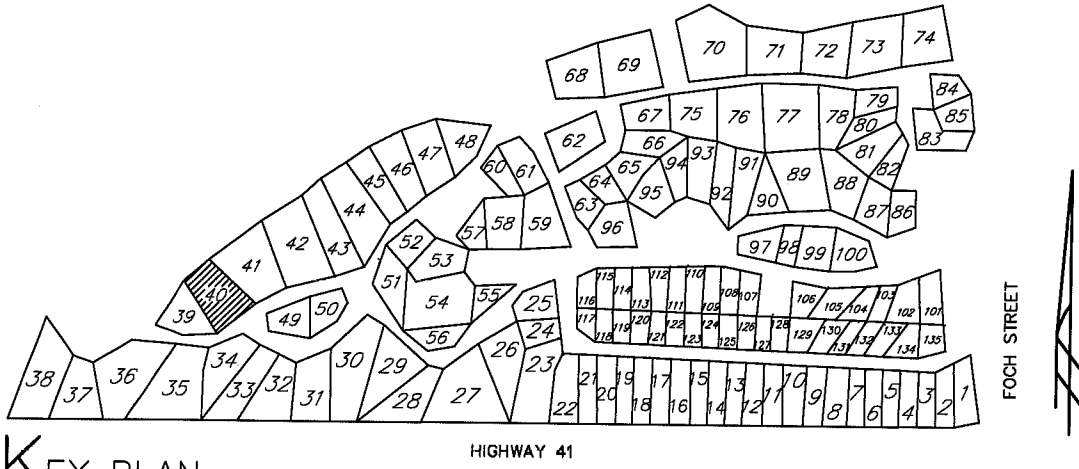

KEY PLAN

- LEGEND**
- Light Pole
  - Septic Tank Lid
  - ⊗ Water Valve
  - Electrical Outlet
  - Ⓟ Telephone Pedestal
  - ◆ 0.013 X 0.450 m small iron post

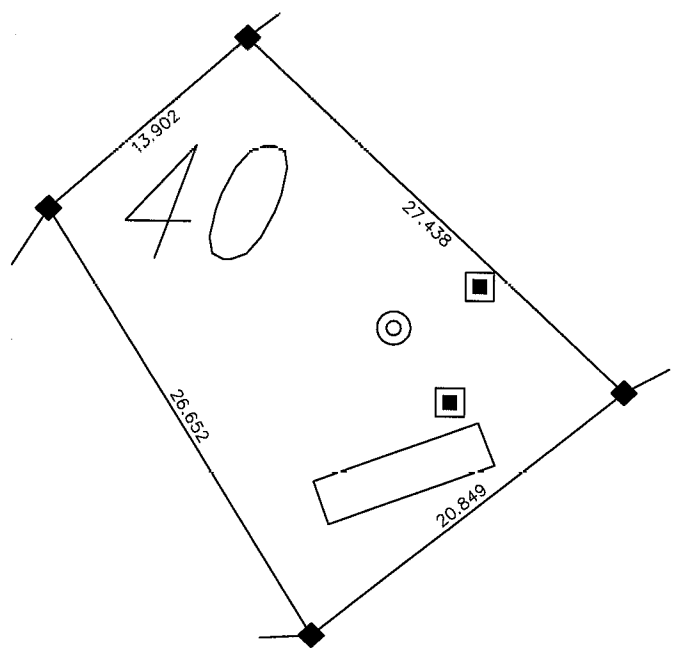

**AREA**  
 sq. m. = 465.91  
 sq. ft. = 5015.0

SCALE  
 1: 400

PREPARED BY:  
  
 Webb Surveys  
 07-1622cs B.J.F.



# POPLAR BEACH



## R.V. RESORT

WAKAW LAKE, SASK.

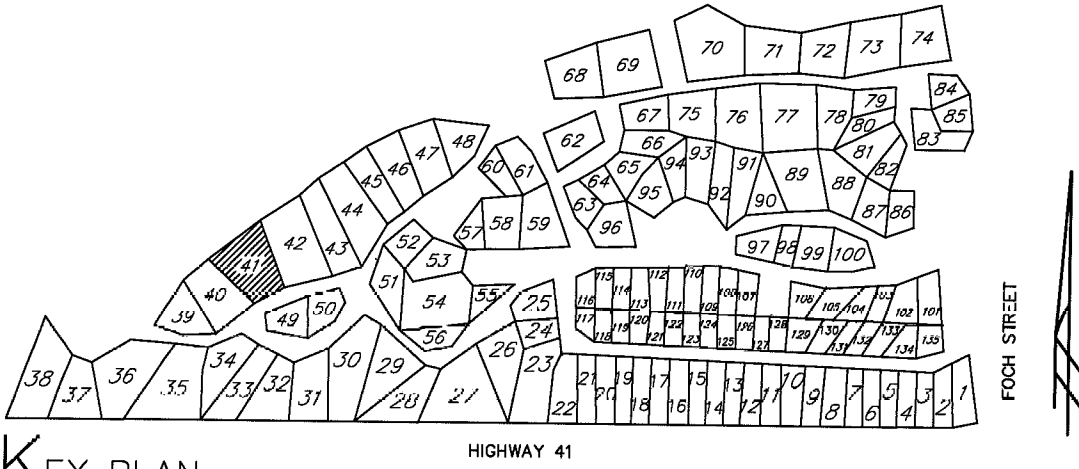

- LEGEND**
- Light Pole
  - Septic Tank Lid
  - ⊗ Water Valve
  - Electrical Outlet
  - Telephone Pedestal
  - ◆ 0.013 X 0.450 m small iron post

KEY PLAN

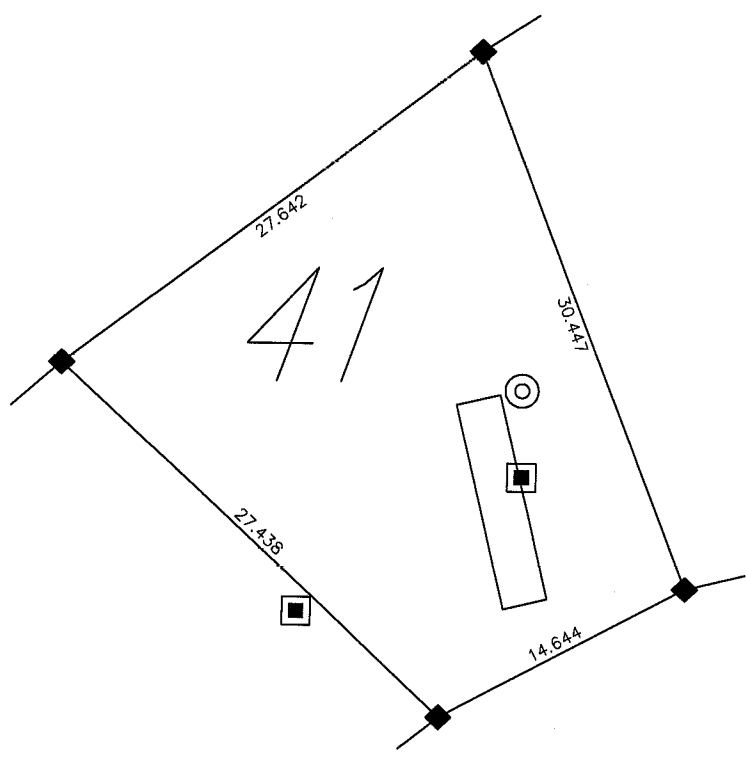

AREA	
sq. m.	= 594.57
sq. ft.	= 6399.9

SCALE  
1:400

PREPARED BY:  
  
**Webb Surveys**  
 07-1622cs B.J.F.

# POPLAR BEACH



## R.V. RESORT

WAKAW LAKE, SASK.

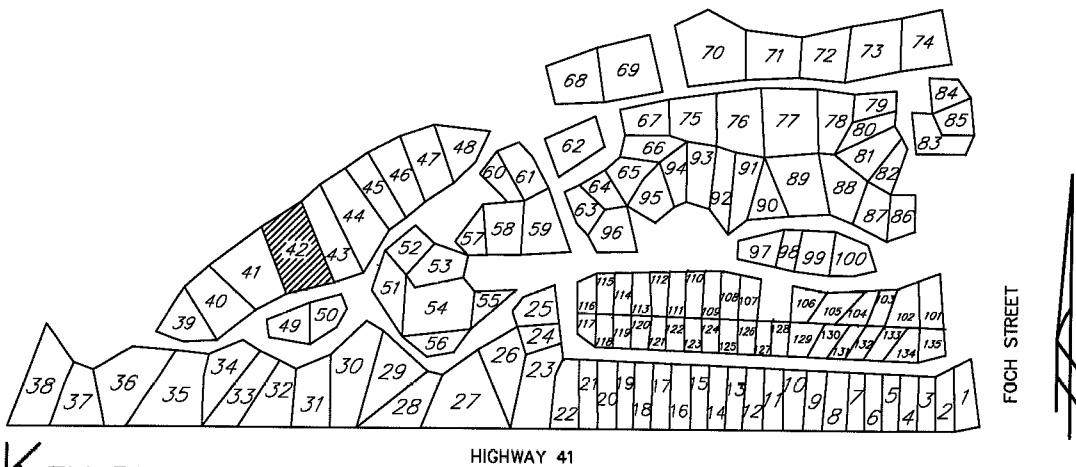

### LEGEND

- Light Pole
- Septic Tank Lid
- ⊠ Water Valve
- Electrical Outlet
- Telephone Pedestal
- ◆ 0.013 X 0.450 m small iron post

### KEY PLAN

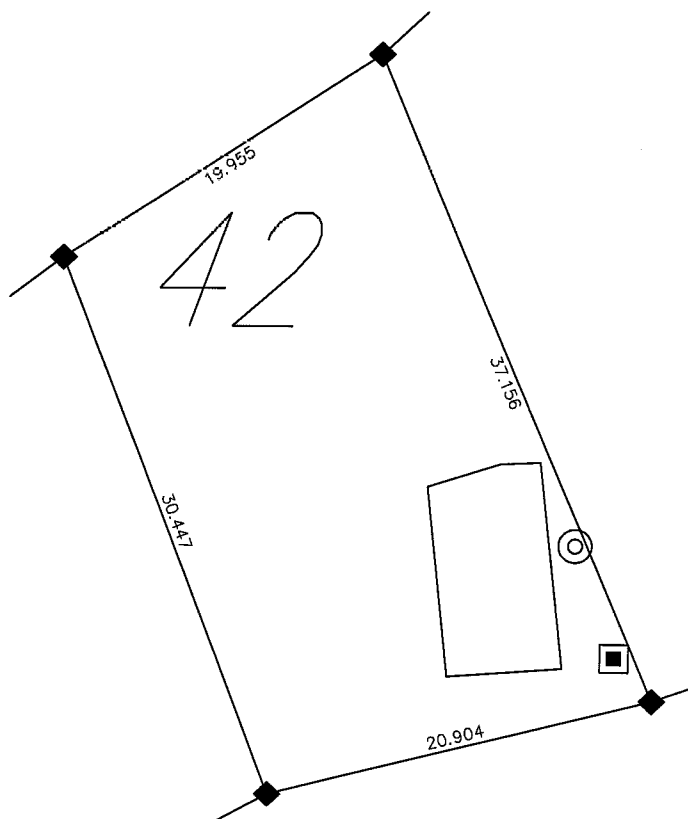

**AREA**  
 sq. m. = 680.92  
 sq. ft. = 7329.3

SCALE  
 1:400

PREPARED BY:  
  
**Webb Surveys**  
 07-1622cs B.J.F.

# POPLAR BEACH



## R.V. RESORT

WAKAW LAKE, SASK.

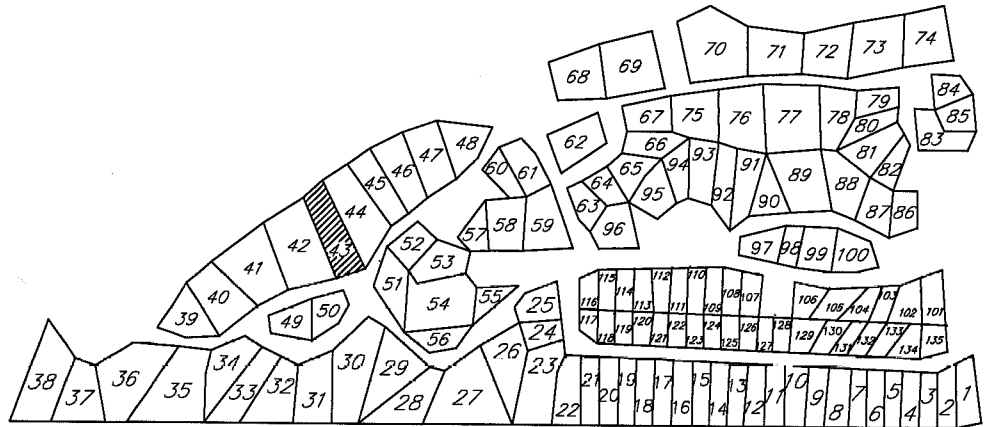

KEY PLAN

HIGHWAY 41

FOCH STREET

**LEGEND**

- Light Pole
- Septic Tank Lid
- ⊠ Water Valve
- Electrical Outlet
- Telephone Pedestal
- ◆ 0.013 X 0.450 m small iron post

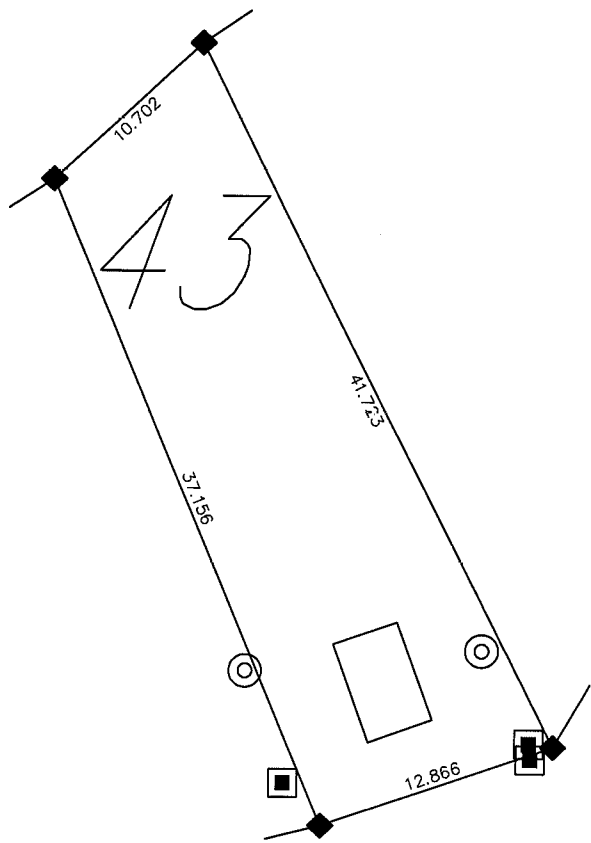

**AREA**  
 sq. m. = 453.16  
 sq. ft. = 4877.8

SCALE  
 1: 400

PREPARED BY:  
  
**Webb Surveys**  
 07-1622cs BJJ

# POPLAR BEACH



## R.V. RESORT

WAKAW LAKE, SASK.

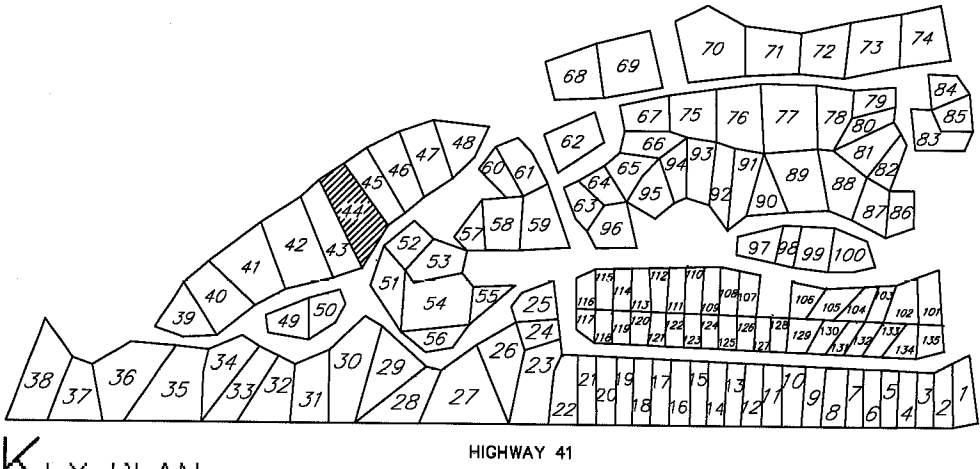

### LEGEND

- Light Pole
- ⊙ Septic Tank Lid
- ⊠ Water Valve
- Electrical Outlet
- Ⓟ Telephone Pedestal
- ◆ 0.013 X 0.450 m small iron post

### KEY PLAN

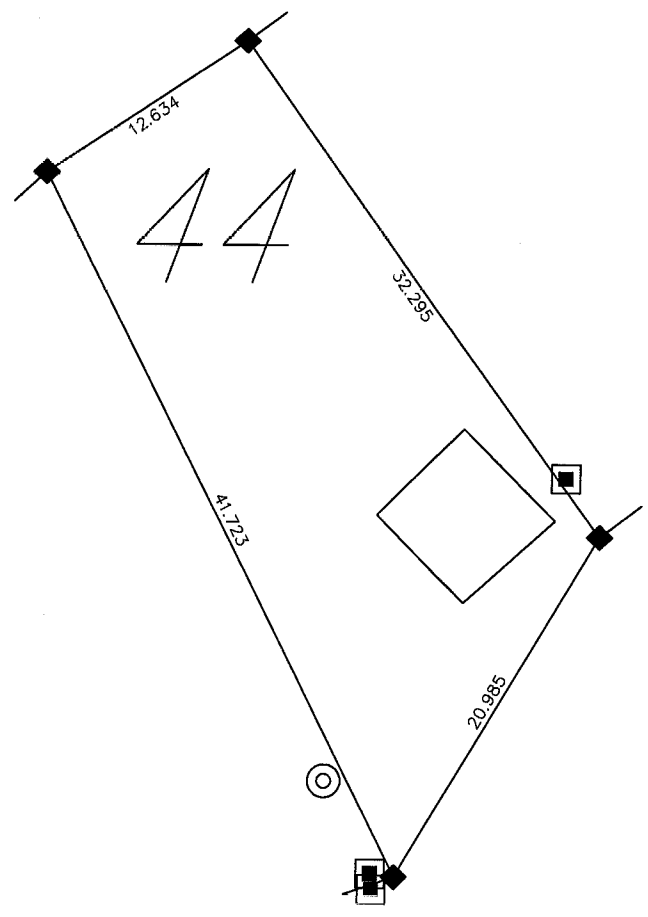

**AREA**  
 sq. m. = 571.98  
 sq. ft. = 6156.7

SCALE  
 1: 400

PREPARED BY:  
  
**Webb Surveys**  
 07-1622cs B/J

# POPLAR BEACH



## R.V. RESORT

WAKAW LAKE, SASK.

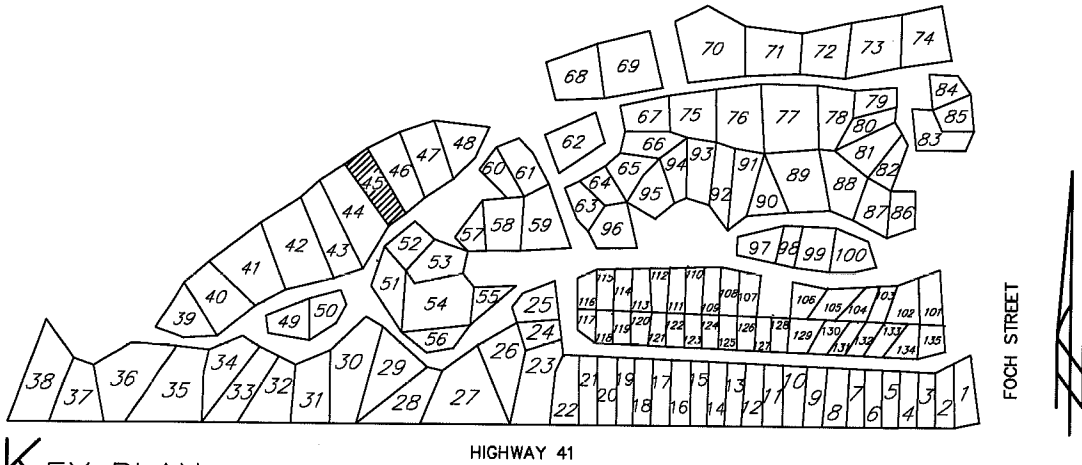

### LEGEND

- Light Pole
- Septic Tank Lid
- ⊗ Water Valve
- Electrical Outlet
- Telephone Pedestal
- ◆ 0.013 X 0.450 m small iron post

### KEY PLAN

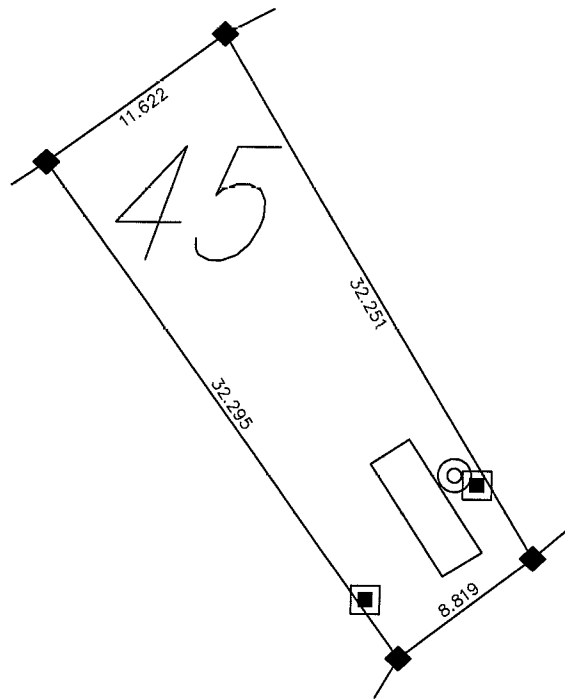

AREA	
sq. m.	= 328.97
sq. ft.	= 3541.0

SCALE  
1: 400

PREPARED BY:  
  
**Webb Surveys**  
 07-1622cs BJB

# POPLAR BEACH



## R.V. RESORT

WAKAW LAKE, SASK.

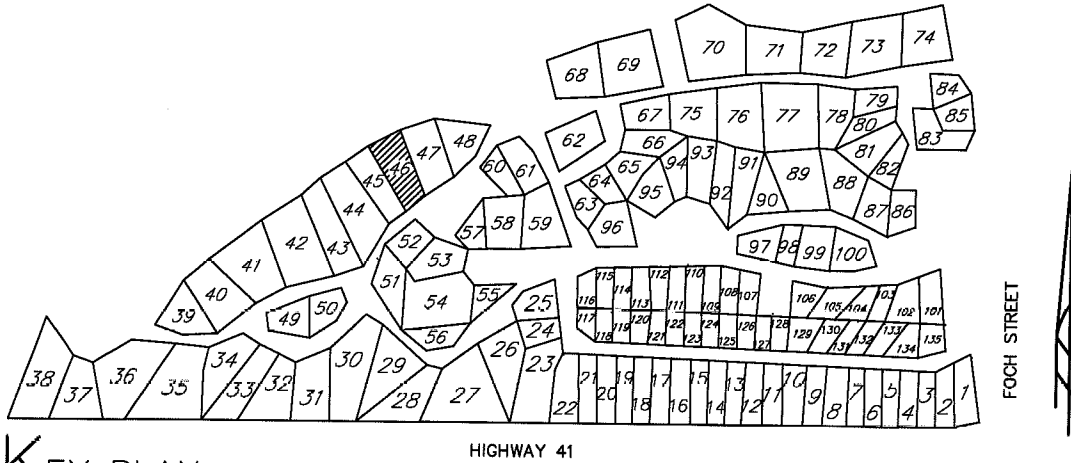

KEY PLAN

### LEGEND

- Light Pole
- ⊙ Septic Tank Lid
- ⊗ Water Valve
- Electrical Outlet
- Ⓟ Telephone Pedestal
- ◆ 0.013 X 0.450 m small iron post

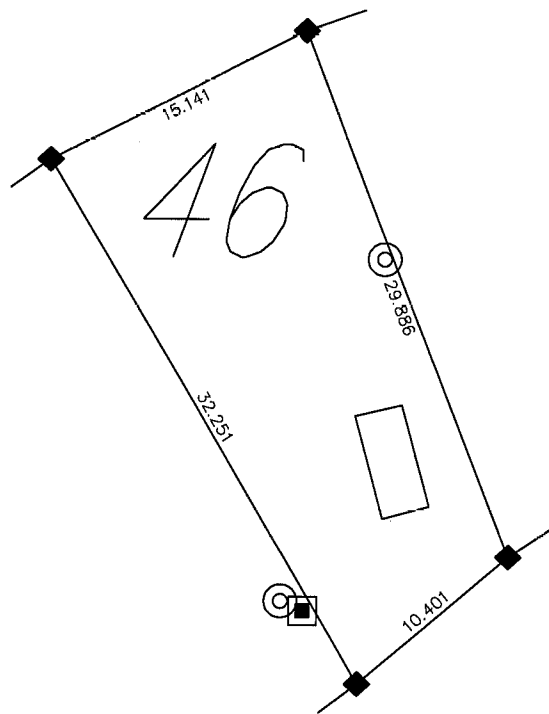

**AREA**  
 sq. m. = 390.31  
 sq. ft. = 4201.3

SCALE  
 1:400

PREPARED BY:  
  
**Webb Surveys**  
 07-1622cs B.J.F.

# POPLAR BEACH



## R.V. RESORT

WAKAW LAKE, SASK.

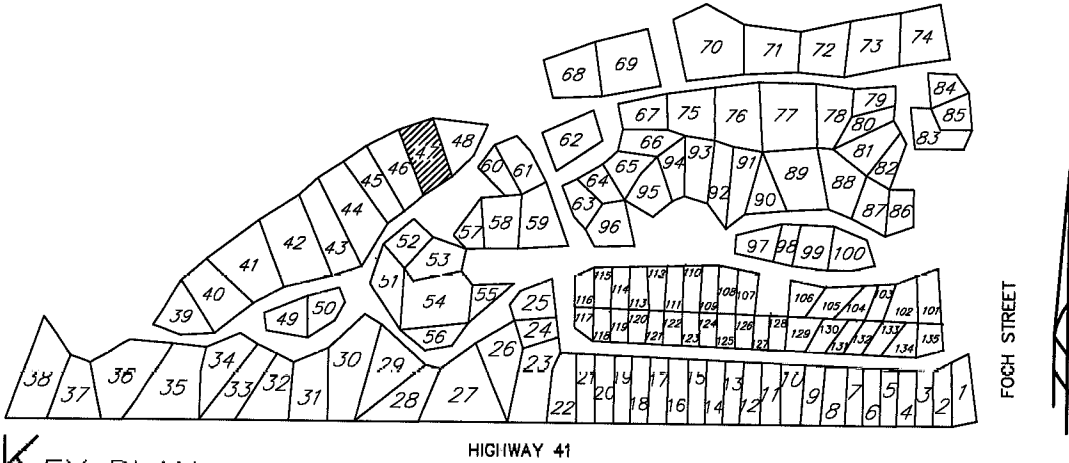

### LEGEND

- Light Pole
- ⊙ Septic Tank Lid
- ⊗ Water Valve
- Electrical Outlet
- Ⓟ Telephone Pedestal
- ◆ 0.013 X 0.450 m small iron post

### KEY PLAN

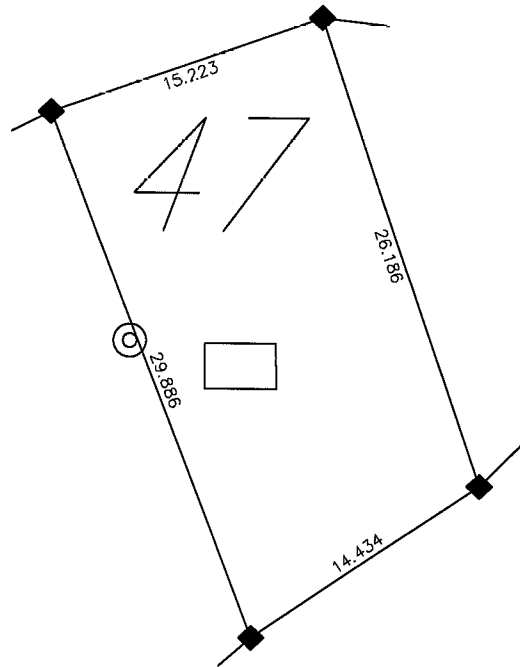

AREA	
sq. m.	= 409.70
sq. ft.	= 4409.9

SCALE  
1:400

PREPARED BY:  
  
**Webb Surveys**

07-1622cs B.J.F.

# POPLAR BEACH



## R.V. RESORT

WAKAW LAKE, SASK.

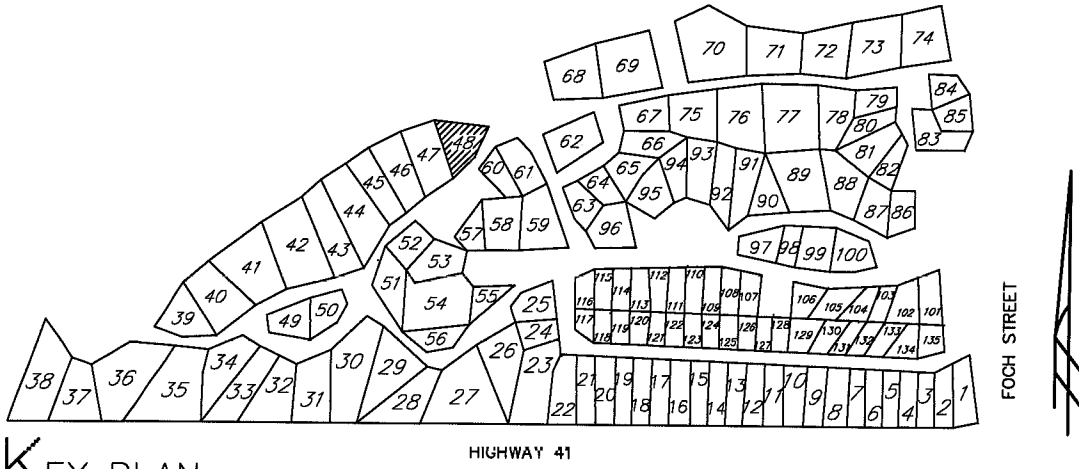

### LEGEND

- Light Pole
- ⊙ Septic Tank Lid
- ⊗ Water Valve
- Electrical Outlet
- Ⓟ Telephone Pedestal
- ◆ 0.013 X 0.450 m small iron post

### KEY PLAN

HIGHWAY 41

FOCH STREET

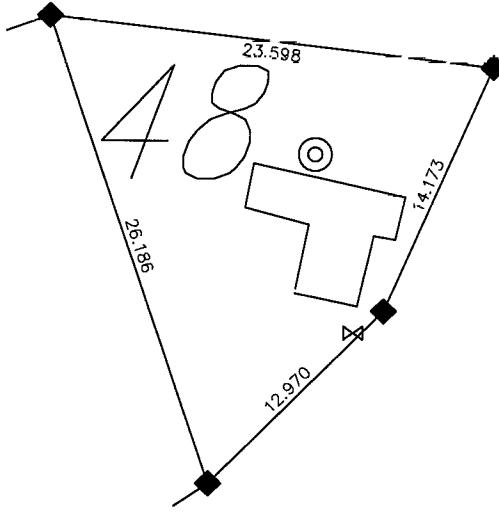

AREA	
sq. m.	= 311.76
sq. ft.	= 3355.7

SCALE  
1: 400

PREPARED BY:  
  
**Webb Surveys**  
 07-1622cs B/J



# POPLAR BEACH



## R.V. RESORT

WAKAW LAKE, SASK.

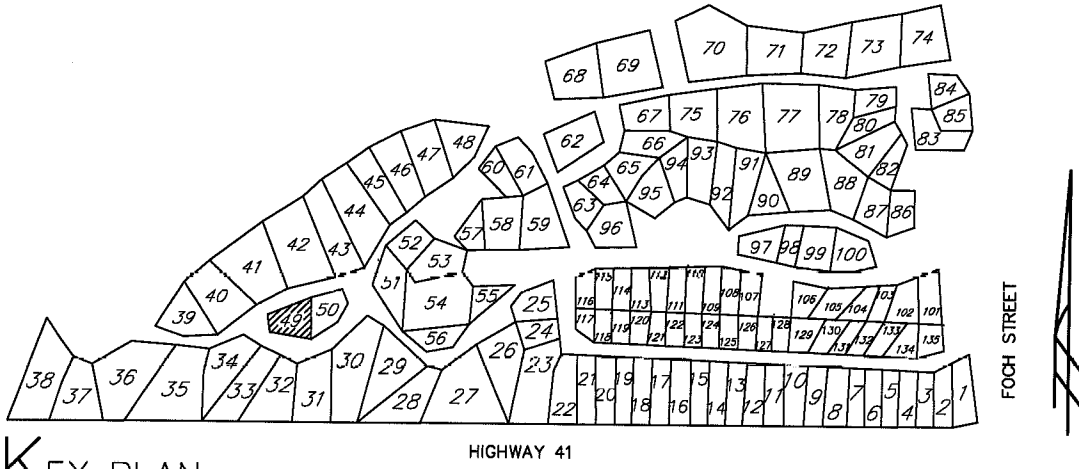

### LEGEND

- Light Pole
- Septic Tank Lid
- ⊠ Water Valve
- Electrical Outlet
- Ⓟ Telephone Pedestal
- ◆ 0.013 X 0.450 m small iron post

### KEY PLAN

HIGHWAY 41

FOCH STREET

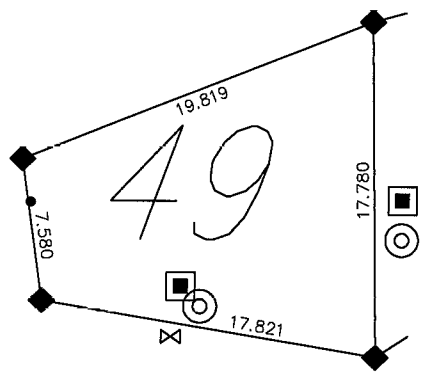

AREA	
sq. m.	= 228.89
sq. ft.	= 2463.7

SCALE  
1: 400

PREPARED BY:  
  
**Webb Surveys**  
 07-1622cs B.J.F.

# POPLAR BEACH



## R.V. RESORT

WAKAW LAKE, SASK.

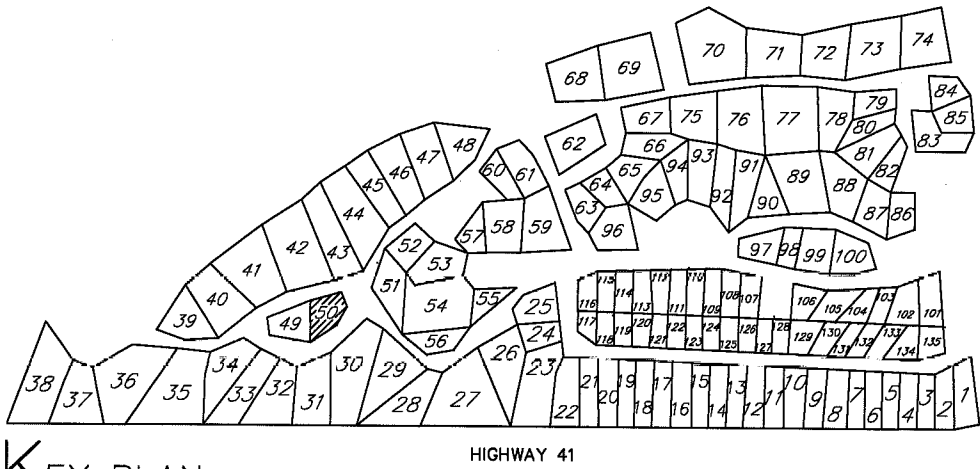

### LEGEND

- Light Pole
- Septic Tank Lid
- ⊗ Water Valve
- Electrical Outlet
- Ⓟ Telephone Pedestal
- ◆ 0.013 X 0.450 m small iron post

### KEY PLAN

HIGHWAY 41

FOC- STREET

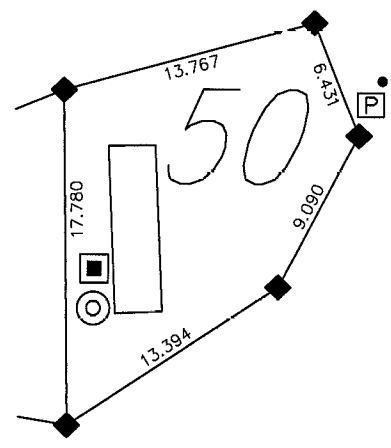

AREA	
sq. m.	= 212.41
sq. ft.	= 2286.3

SCALE  
1:400

PREPARED BY:  
  
**Webb Surveys**  
 07-1622cs B.J.F.

# POPLAR BEACH



## R. V. RESORT

WAKAW LAKE, SASK.

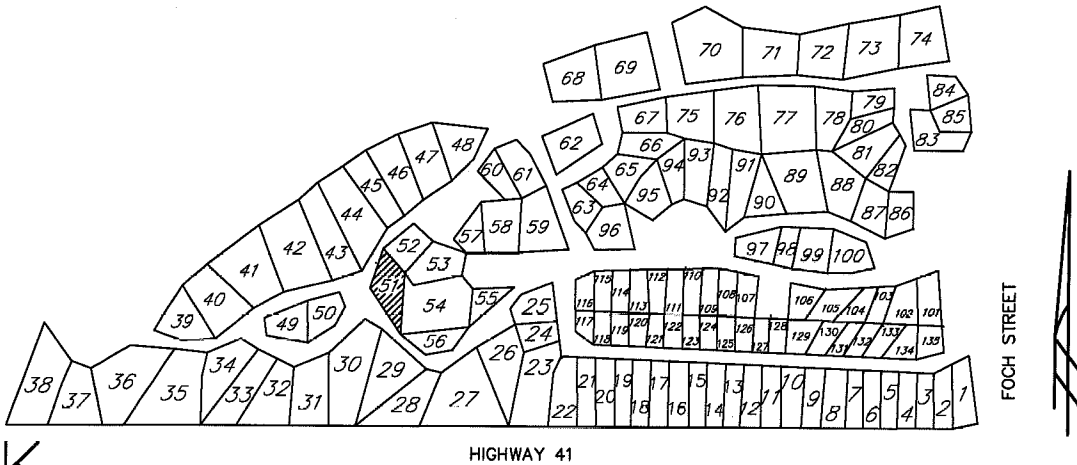

### LEGEND

- Light Pole
- Septic Tank Lid
- ⊠ Water Valve
- Electrical Outlet
- Telephone Pedestal
- ◆ 0.013 X 0.450 m small iron post

### KEY PLAN

HIGHWAY 41

FOCH STREET

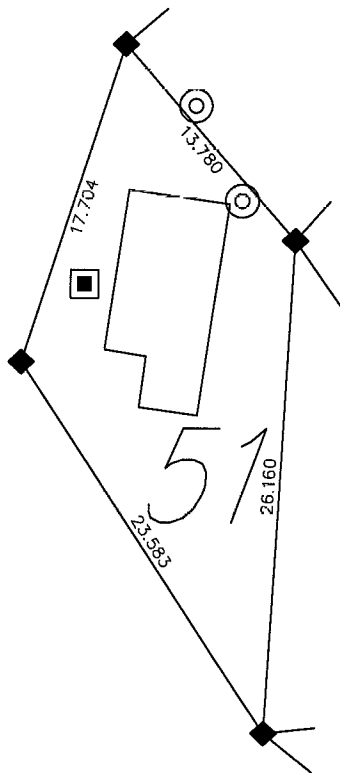

**AREA**  
 sq. m. = 289.83  
 sq. ft. = 3119.7

SCALE  
 1: 400

PREPARED BY:



07-1622cs BJB

# POPLAR BEACH



## R. V. RESORT

WAKAW LAKE, SASK.

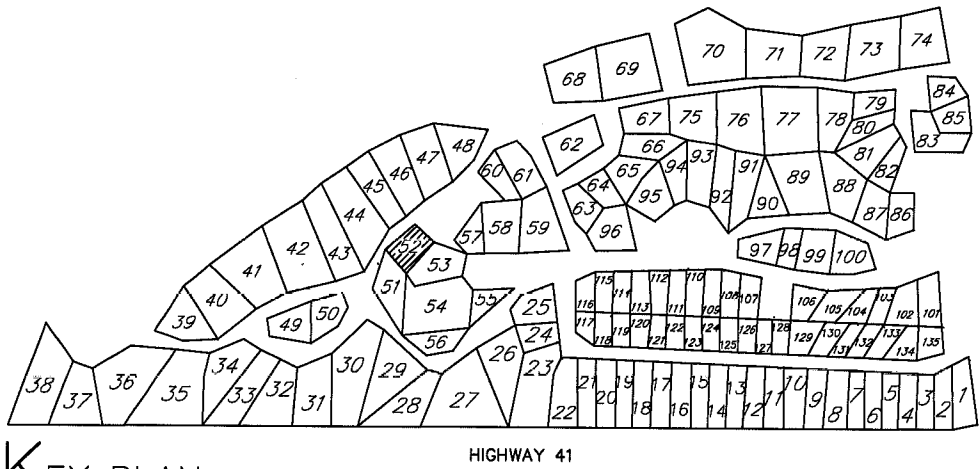

### LEGEND

- Light Pole
- ⊙ Septic Tank Lid
- ⊗ Water Valve
- Electrical Outlet
- Ⓟ Telephone Pedestal
- ◆ 0.013 X 0.450 m small iron post

### KEY PLAN

HIGHWAY 41

FOCH STREET

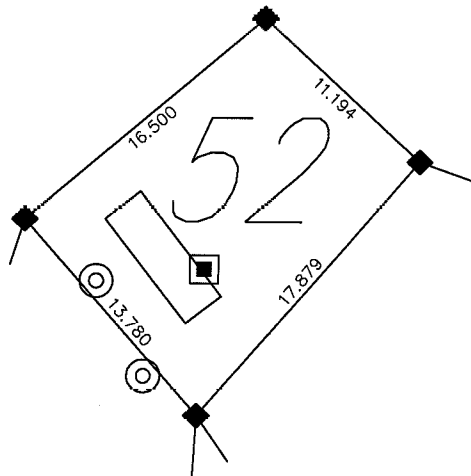

AREA	
sq. m.	= 213.71
sq. ft.	= 2300.3

SCALE  
1: 400

PREPARED BY:

Webb Surveys

07-1622cs B/J

# POPLAR BEACH



## R.V. RESORT

WAKAW LAKE, SASK.

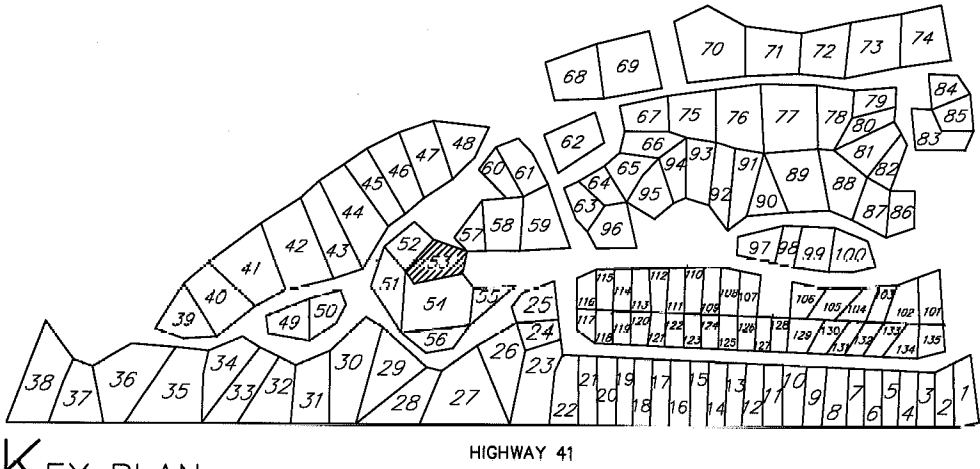

- LEGEND**
- Light Pole
  - ⊙ Septic Tank Lid
  - ⊗ Water Valve
  - Electrical Outlet
  - P Telephone Pedestal
  - ◆ 0.013 X 0.450 m small iron post

### KEY PLAN

HIGHWAY 41

FOCH STREET

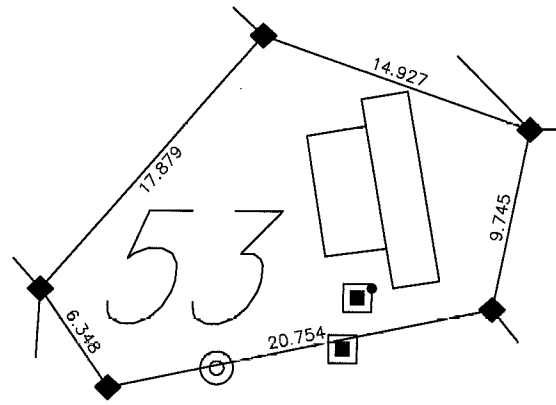

AREA	
sq. m.	= 299.69
sq. ft.	= 3225.8

SCALE  
1:400

PREPARED BY:  
  
**Webb Surveys**  
 07-1622cs B.J.F.

# POPLAR BEACH



## R.V. RESORT

WAKAW LAKE, SASK.

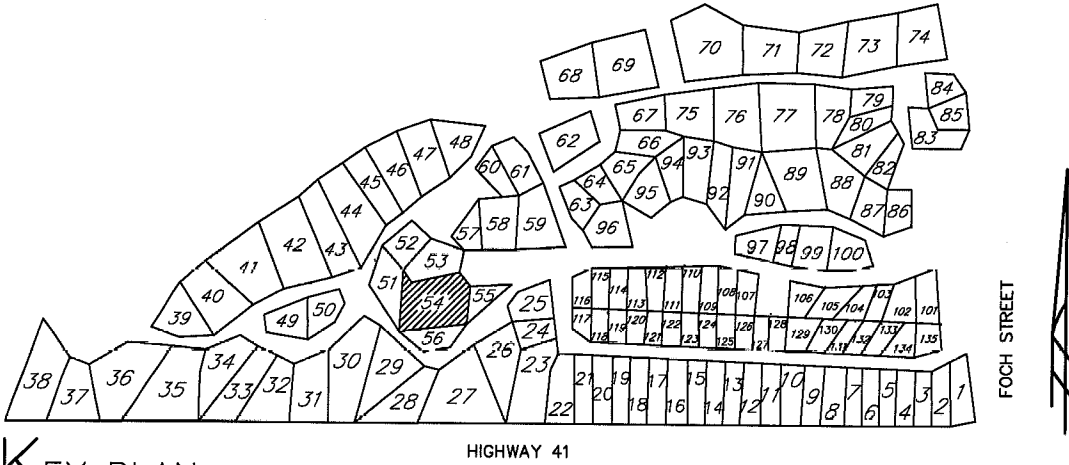

### LEGEND

- Light Pole
- Septic Tank Lid
- ⊗ Water Valve
- Electrical Outlet
- Ⓟ Telephone Pedestal
- ◆ 0.013 X 0.450 m small iron post

### KEY PLAN

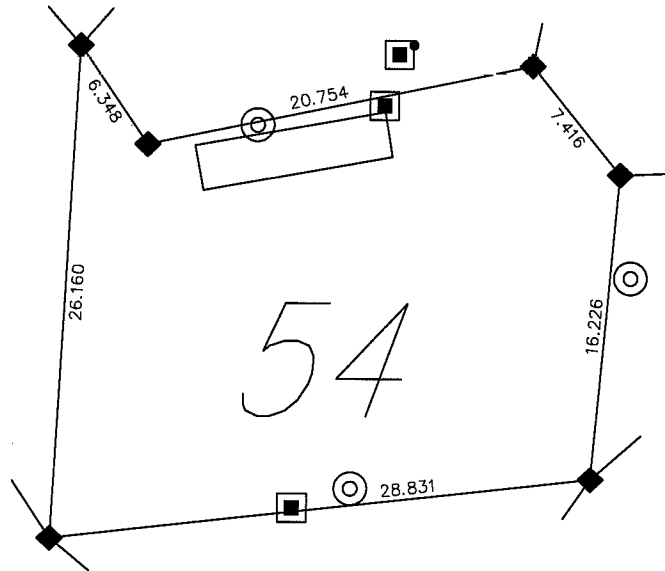

**AREA**  
 sq. m. = 613.55  
 sq. ft. = 6604.2

SCALE  
 1:400

PREPARED BY:  
  
**Webb Surveys**

07-1622cs B/J

# POPLAR BEACH



## R. V. RESORT

WAKAW LAKE, SASK.

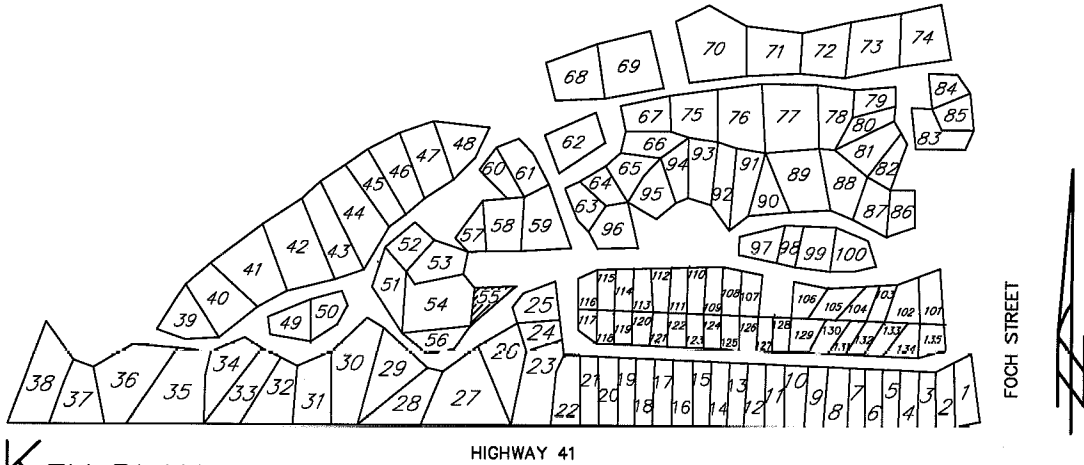

### LEGEND

- Light Pole
- ⊙ Septic Tank Lid
- ⊗ Water Valve
- Electrical Outlet
- Ⓟ Telephone Pedestal
- ◆ 0.013 X 0.450 m small iron post

### KEY PLAN

HIGHWAY 41

FOCH STREET

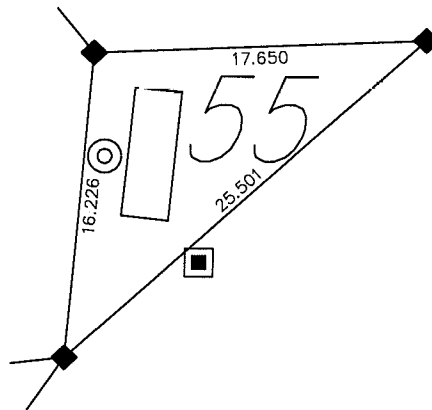

AREA	
sq. m.	= 141.94
sq. ft.	= 1527.8

SCALE  
1:400

PREPARED BY:

Webb Surveys

07-1622cs DJF

# POPLAR BEACH



## R.V. RESORT

WAKAW LAKE, SASK.

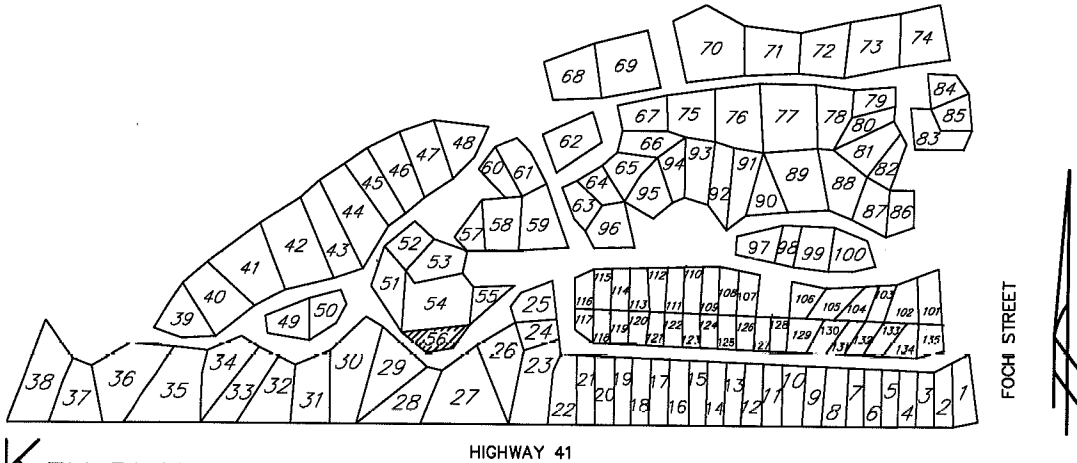

KEY PLAN

### LEGEND

- Light Pole
- ⊙ Septic Tank Lid
- ⊗ Water Valve
- Electrical Outlet
- Ⓟ Telephone Pedestal
- ◆ 0.013 X 0.450 m small iron post

**AREA**  
 sq. m. = 187.97  
 sq. ft. = 2023.3

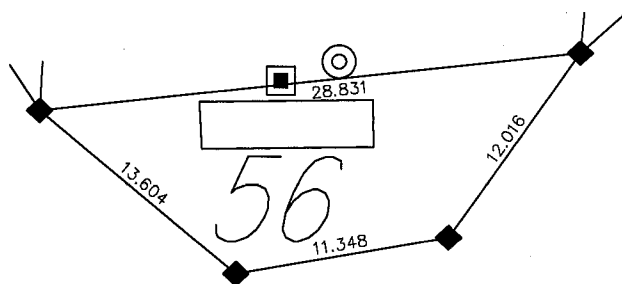

SCALE  
1:400

PREPARED BY:

**Webb Surveys**

07-1622cs B/J



# POPLAR BEACH



## R. V. RESORT

WAKAW LAKE, SASK.

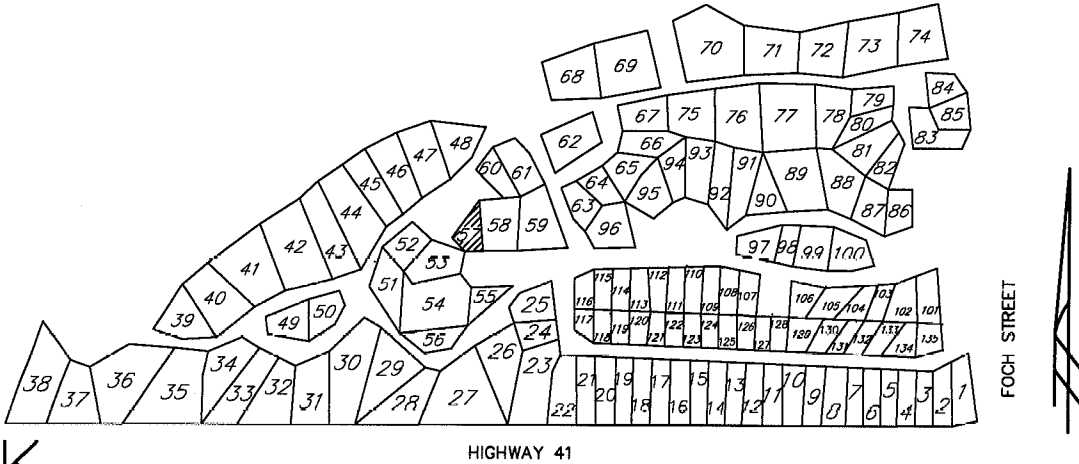

### LEGEND

- Light Pole
- Septic Tank Lid
- ⊗ Water Valve
- Electrical Outlet
- Ⓟ Telephone Pedestal
- ◆ 0.013 X 0.450 m small iron post

### KEY PLAN

HIGHWAY 41

FOCH STREET

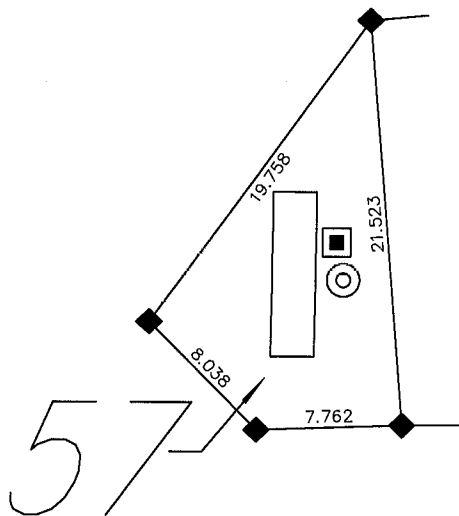

**AREA**  
 sq. m. = 161.79  
 sq. ft. = 1741.5

SCALE  
 1:400

PREPARED BY:

*Webb Surveys*

07-162268 B/J

# POPLAR BEACH



## R.V. RESORT

WAKAW LAKE, SASK.

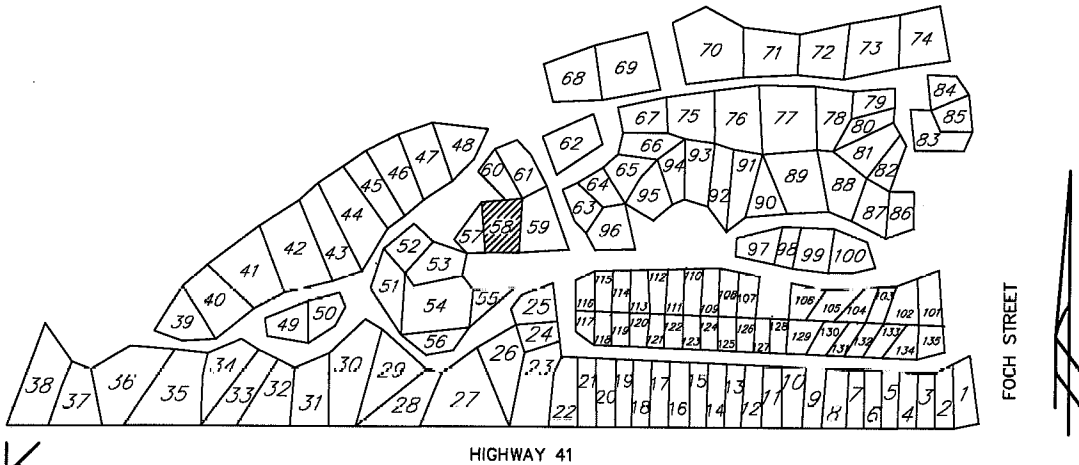

### LEGEND

- Light Pole
- Septic Tank Lid
- ⊗ Water Valve
- Electrical Outlet
- Ⓟ Telephone Pedestal
- ◆ 0.013 X 0.450 m small Iron post

### KEY PLAN

HIGHWAY 41

FOCH STREET

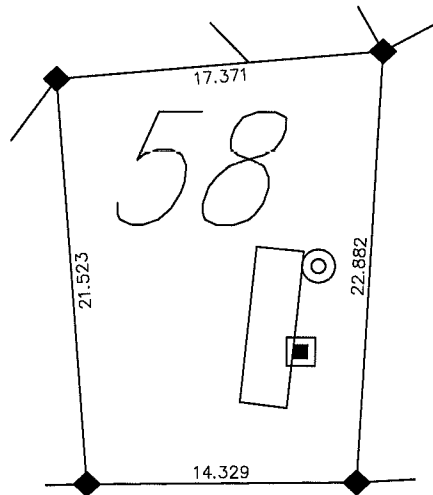

AREA	
sq. m.	= 350.54
sq. ft.	= 3773.1

PREPARED BY:



Webb Surveys

07-1622cs B.J.F.

SCALE  
1:400

# POPLAR BEACH



## R.V. RESORT

WAKAW LAKE, SASK.

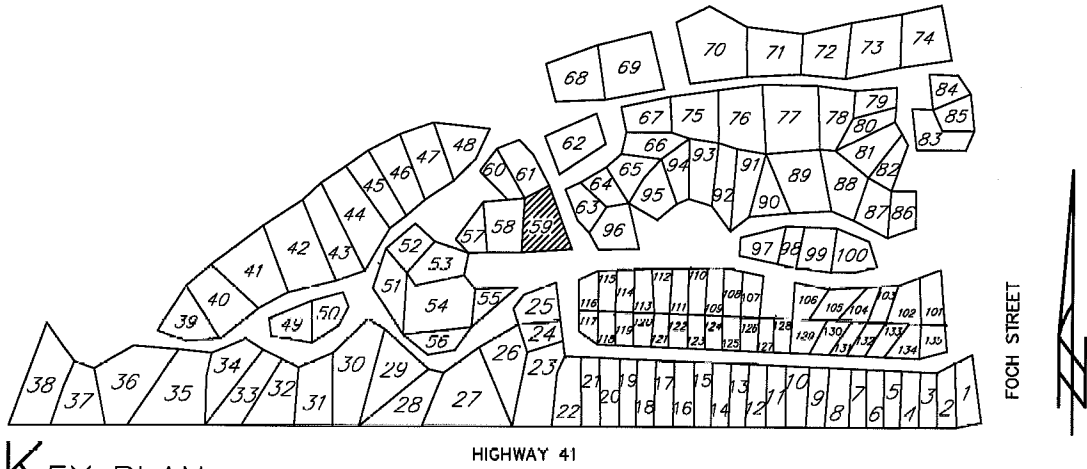

### LEGEND

- Light Pole
- ⊙ Septic Tank Lid
- ⊗ Water Valve
- Electrical Outlet
- Ⓟ Telephone Pedestal
- ◆ 0.013 X 0.450 m small iron post

### KEY PLAN

HIGHWAY 41

FOCH STREET

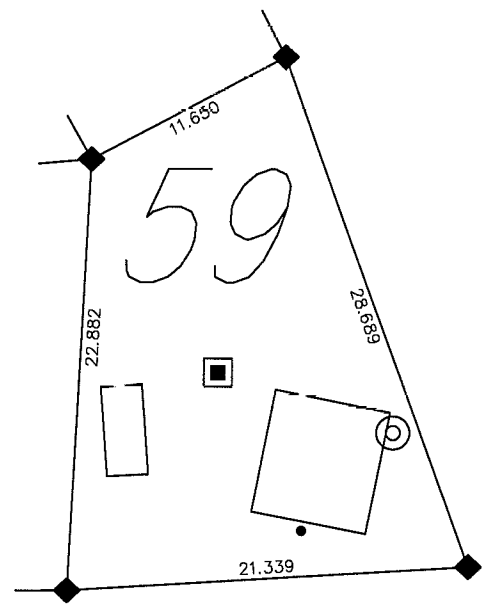

AREA	
sq. m.	= 408.04
sq. ft.	= 4392.1

SCALE  
1:400

PREPARED BY:  
  
**Webb Surveys**  
 07-1622cs BJF

# POPLAR BEACH



## R. V. RESORT

WAKAW LAKE, SASK.

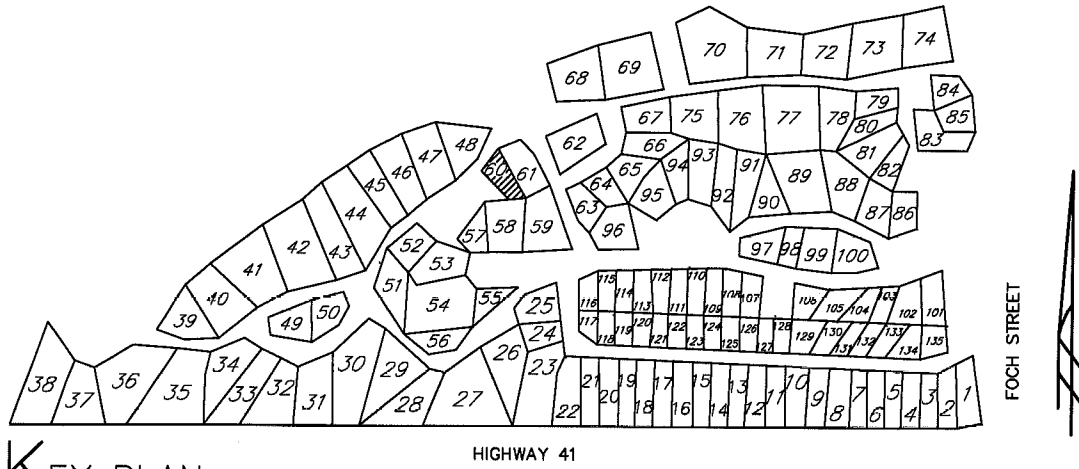

### LEGEND

- Light Pole
- ⊙ Septic Tank Lid
- ⊗ Water Valve
- Electrical Outlet
- Ⓟ Telephone Pedestal
- ◆ 0.013 X 0.450 m small iron post

### KEY PLAN

HIGHWAY 41

FOCH STREET

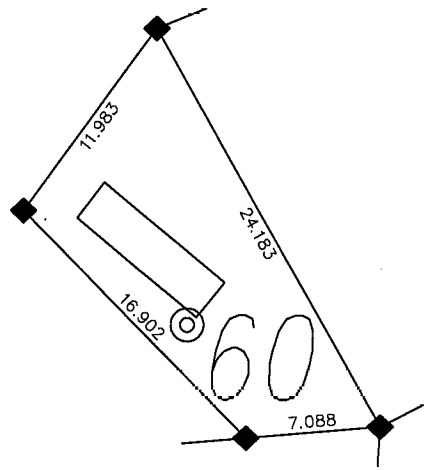

**AREA**  
 sq. m. = 178.03  
 sq. ft. = 1916.3

SCALE  
 1:400

PREPARED BY:



07-1622cs B.J.F.

# POPLAR BEACH



## R.V. RESORT

WAKAW LAKE, SASK.

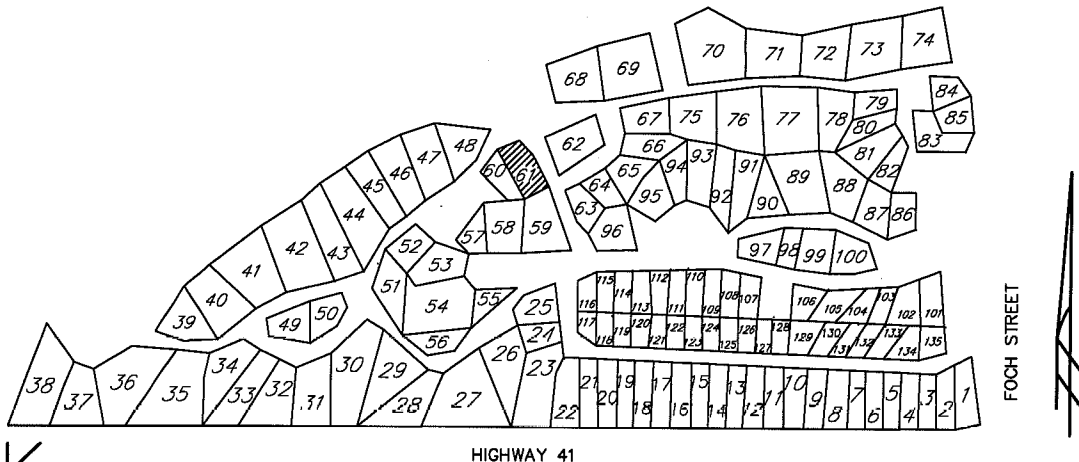

### LEGEND

- Light Pole
- Septic Tank Lid
- ⊗ Water Valve
- Electrical Outlet
- Telephone Pedestal
- ◆ 0.013 X 0.450 m small iron post

### KEY PLAN

HIGHWAY 41

FOCH STREET

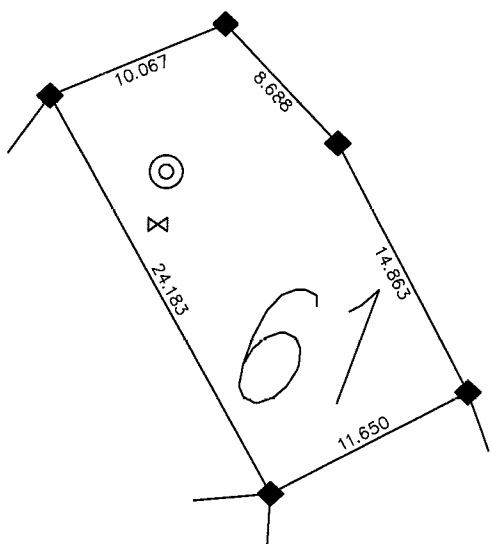

AREA	
sq. m.	= 273.81
sq. ft.	= 2947.3

SCALE  
1: 400

PREPARED BY:  
  
**Webb Surveys**  
 07-1622cs B.J.F.

# POPLAR BEACH



## R. V. RESORT

WAKAW LAKE, SASK.

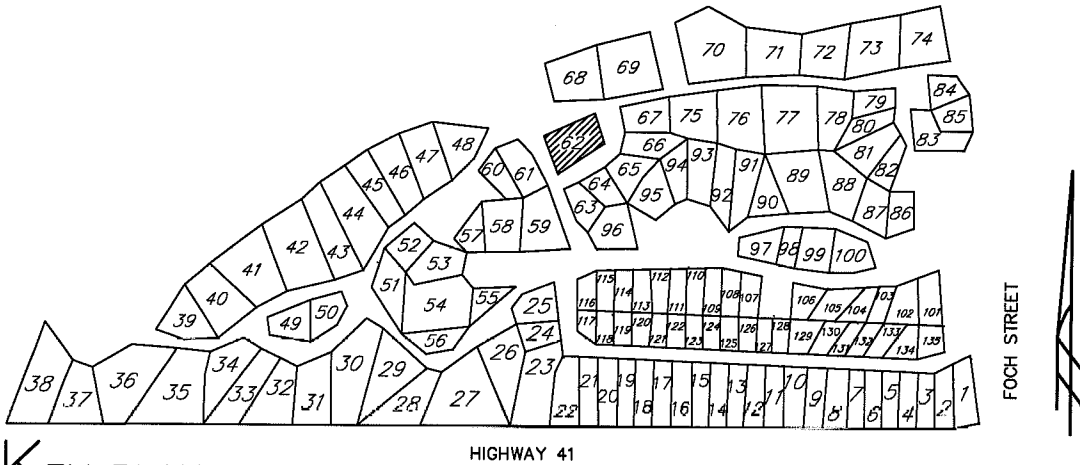

KEY PLAN

HIGHWAY 41

FOCH STREET

**LEGEND**

- Light Pole
- Septic Tank Lid
- ⊠ Water Valve
- Electrical Outlet
- Telephone Pedestal
- ◆ 0.013 X 0.150 m small iron post

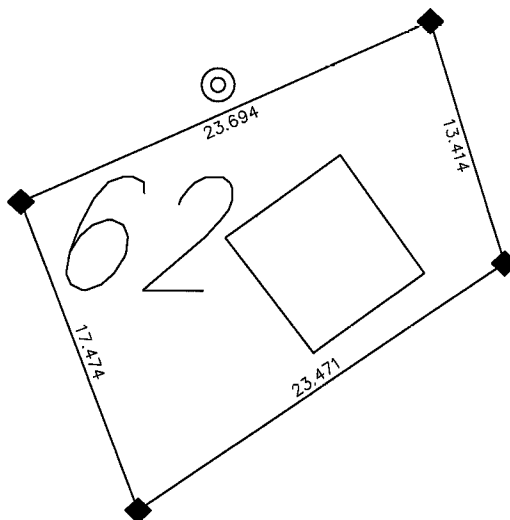

AREA	
sq. m. =	357.36
sq. ft. =	3846.6

SCALE  
1:400

PREPARED BY:



07-1622CS R.J.F

# POPLAR BEACH



## R. V. RESORT

WAKAW LAKE, SASK.

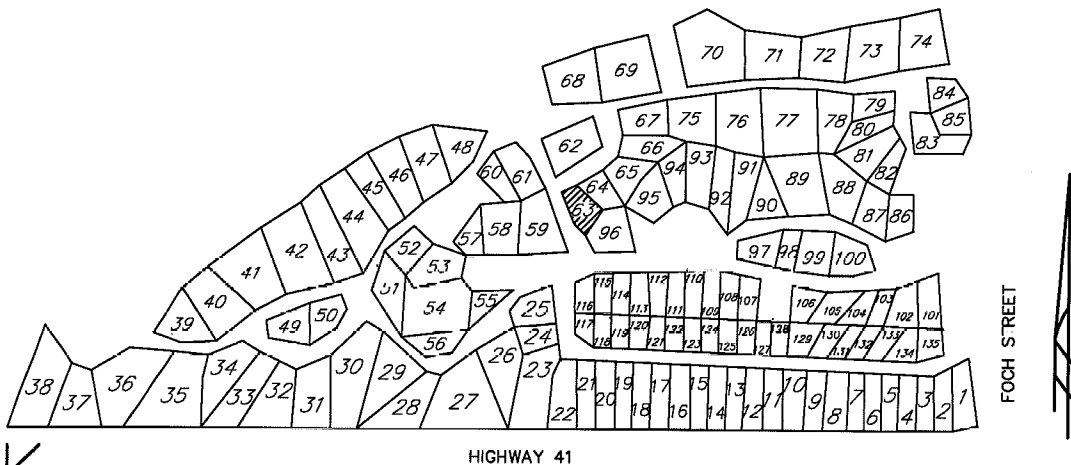

### LEGEND

- Light Pole
- Septic Tank Lid
- ⊗ Water Valve
- Electrical Outlet
- Ⓟ Telephone Pedestal
- ◆ 0.013 X 0.450 m small iron post

### KEY PLAN

HIGHWAY 41

FOCH STREET

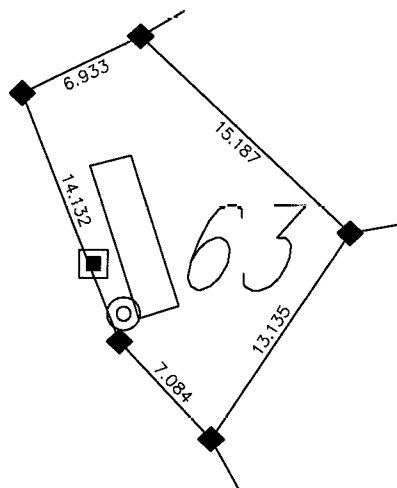

AREA	
sq. m.	= 189.16
sq. ft.	= 2036.1

SCALE  
1:400

PREPARED BY:

Webb Surveys

07-1622cs B.J.F.

# POPLAR BEACH



## R.V. RESORT

WAKAW LAKE, SASK.

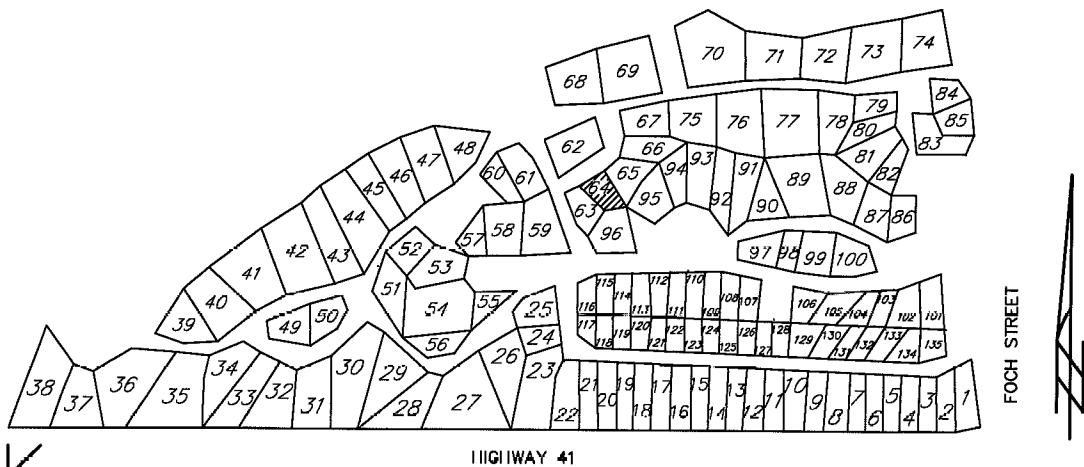

### KEY PLAN

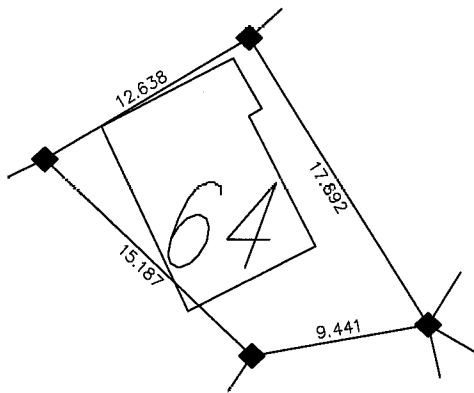

AREA	
sq. m.	= 170.65
sq. ft.	= 1836.8

SCALE  
1:400

PREPARED BY:

Webb Surveys

07-1622cs B/J



# POPLAR BEACH



## R. V. RESORT

WAKAW LAKE, SASK.

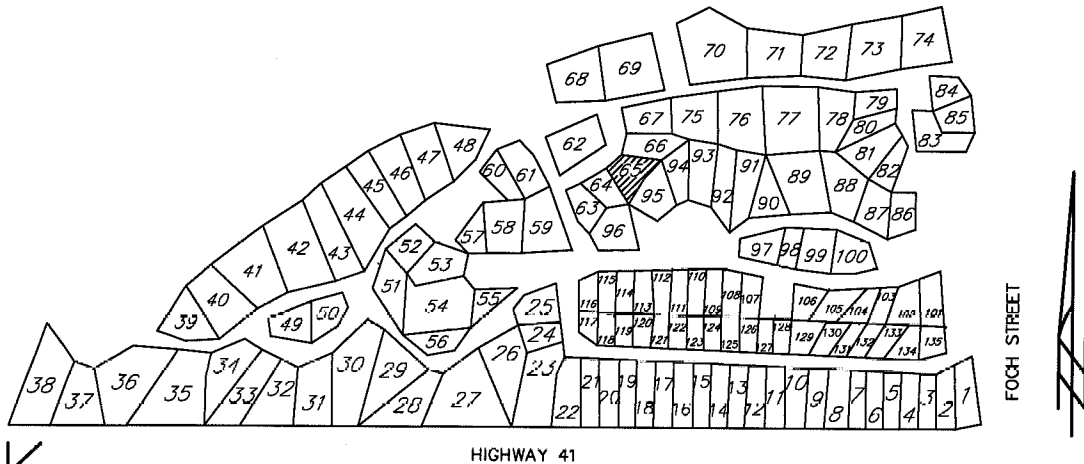

### LEGEND

- Light Pole
- ⊙ Septic Tank Lid
- ⊗ Water Valve
- Electrical Outlet
- ⊡ Telephone Pedestal
- ◆ 0.013 x 0.450 m small iron post

### KEY PLAN

HIGHWAY 41

FOCH STREET

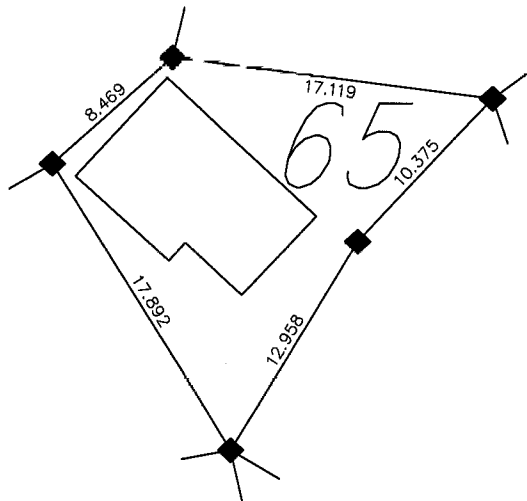

AREA	
sq. m.	= 234.33
sq. ft.	= 2522.3

SCALE  
1:400

PREPARED BY:

Webb Surveys

07-1622cs B.J.F.

# POPLAR BEACH



## R. V. RESORT

WAKAW LAKE, SASK.

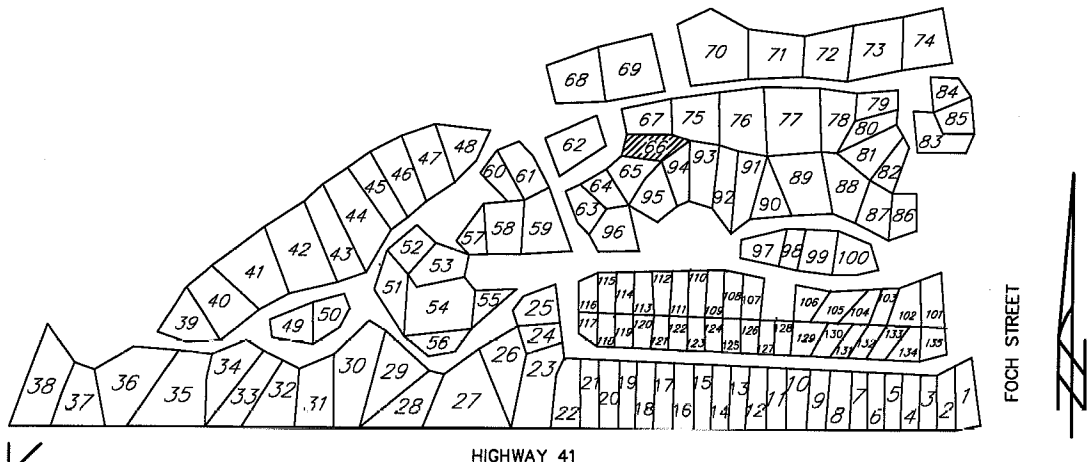

KEY PLAN

HIGHWAY 41

FOCH STREET

**LEGEND**

- Light Pole
- Septic Tank Lid
- ⊗ Water Valve
- Electrical Outlet
- Telephone Pedestal
- ◆ 0.013 X 0.450 m small iron post

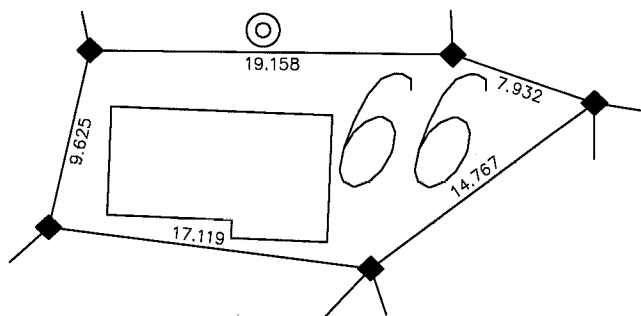

**AREA**  
 sq. m. = 239.27  
 sq. ft. = 2575.5

SCALE  
 1:400

PREPARED BY:



07-1622cs B.J.F.

# POPLAR BEACH



## R. V. RESORT

WAKAW LAKE, SASK.

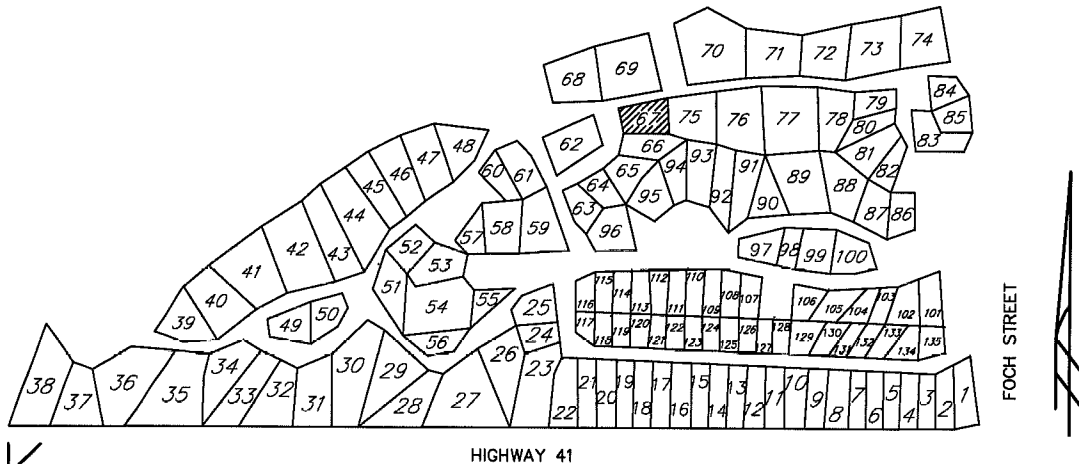

### LEGEND

- Light Pole
- Septic Tank Lid
- ⊗ Water Valve
- Electrical Outlet
- Telephone Pedestal
- ◆ 0.013 X 0.450 m small iron post

### KEY PLAN

HIGHWAY 41

FOCH STREET

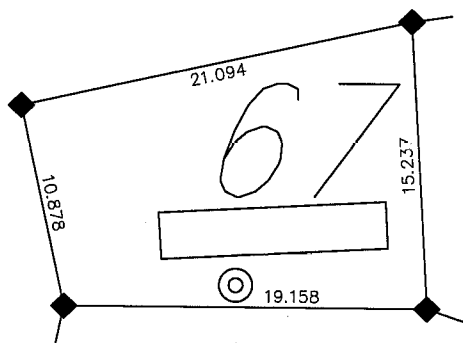

AREA	
sq. m.	= 260.41
sq. ft.	= 2803.0

SCALE  
1:400

PREPARED BY:



07-1622cs B.J.F.

# POPLAR BEACH



## R.V. RESORT

WAKAW LAKE, SASK.

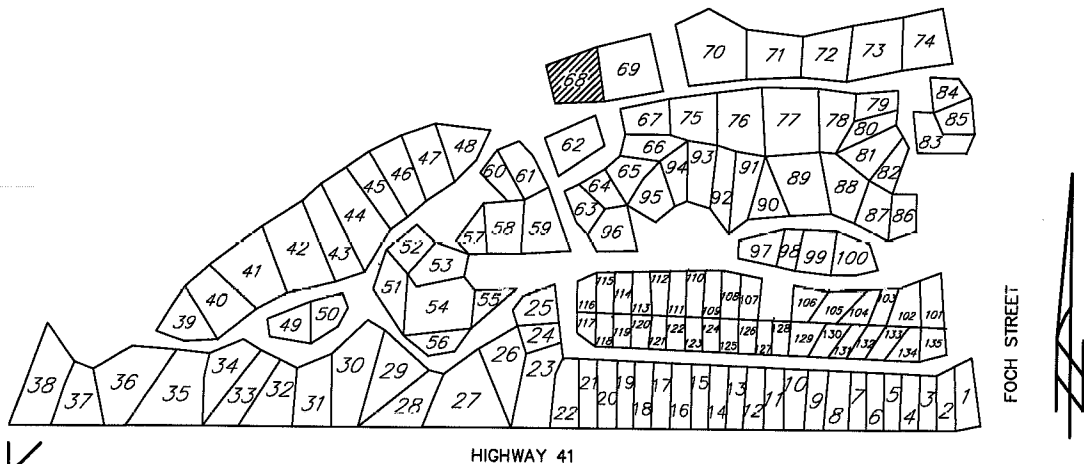

### LEGEND

- Light Pole
- Septic Tank Lid
- ⊠ Water Valve
- Electrical Outlet
- Telephone Pedestal
- ◆ 0.013 X 0.450 m small iron post

### KEY PLAN

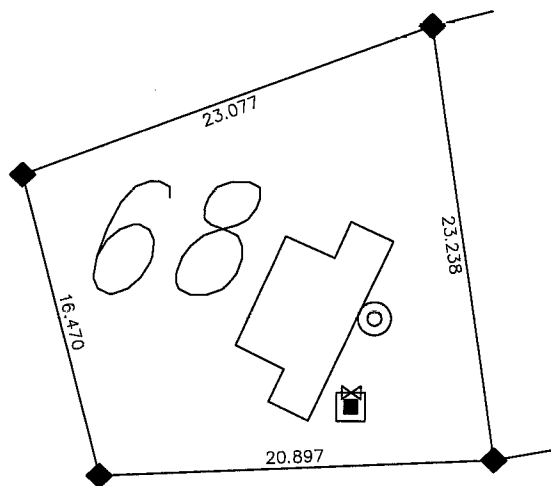

AREA	
sq. m.	= 430.68
sq. ft.	= 4635.8

SCALE  
1: 400

PREPARED BY:



07-1622cs BJJ

# POPLAR BEACH

## R.V. RESORT

WAKAW LAKE, SASK.

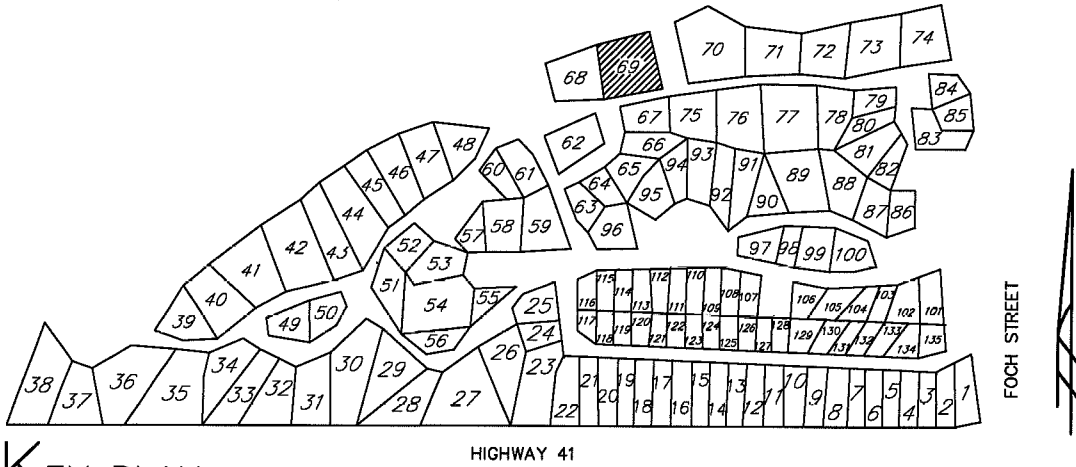

### LEGEND

- Light Pole
- Septic Tank Lid
- ⊗ Water Valve
- Electrical Outlet
- P Telephone Pedestal
- ◆ 0.013 X 0.450 m small iron post

### KEY PLAN

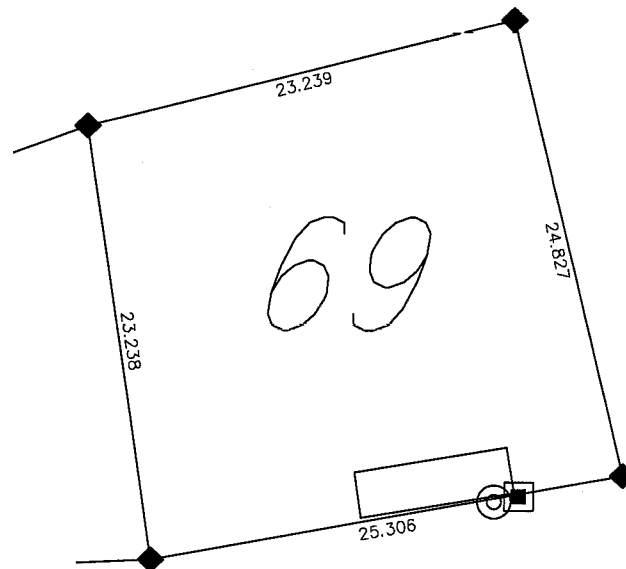

AREA	
sq. m.	= 582.36
sq. ft.	= 6268.4

SCALE  
1:400

PREPARED BY:

**Webb Surveys**

07-1622cs BJF

# POPLAR BEACH



## R. V. RESORT

WAKAW LAKE, SASK.

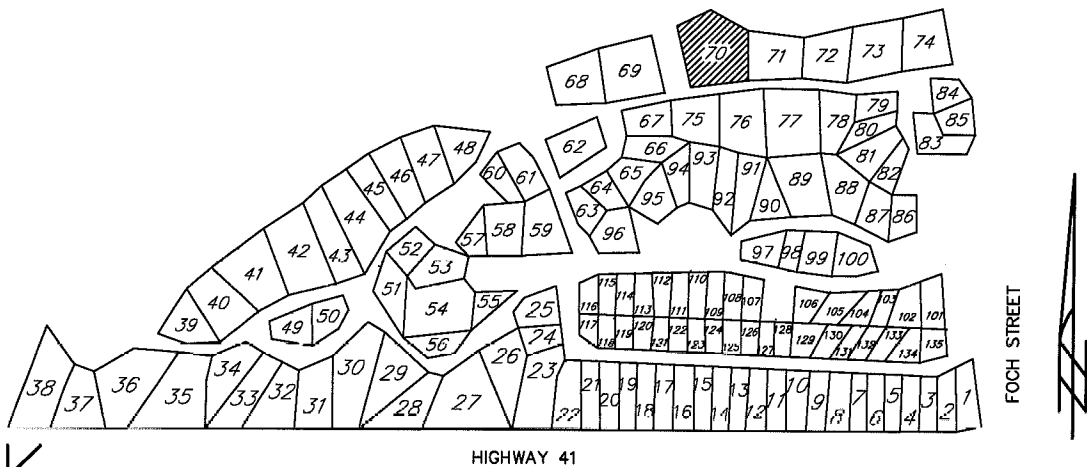

KEY PLAN

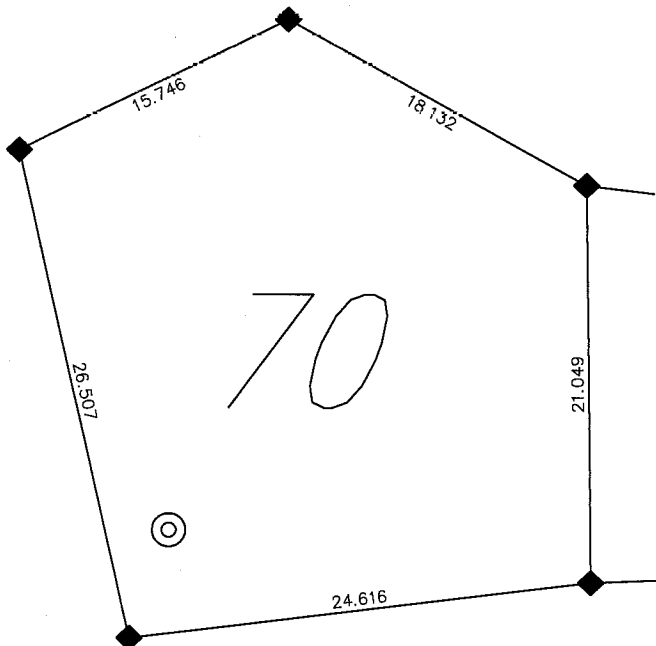

**AREA**  
 sq. m. = 757.04  
 sq. ft. = 8148.7

SCALE  
 1:400

PREPARED BY:  
  
**Webb Surveys**  
 07-1622cc B.J.F.

# POPLAR BEACH



## R. V. RESORT

WAKAW LAKE, SASK.

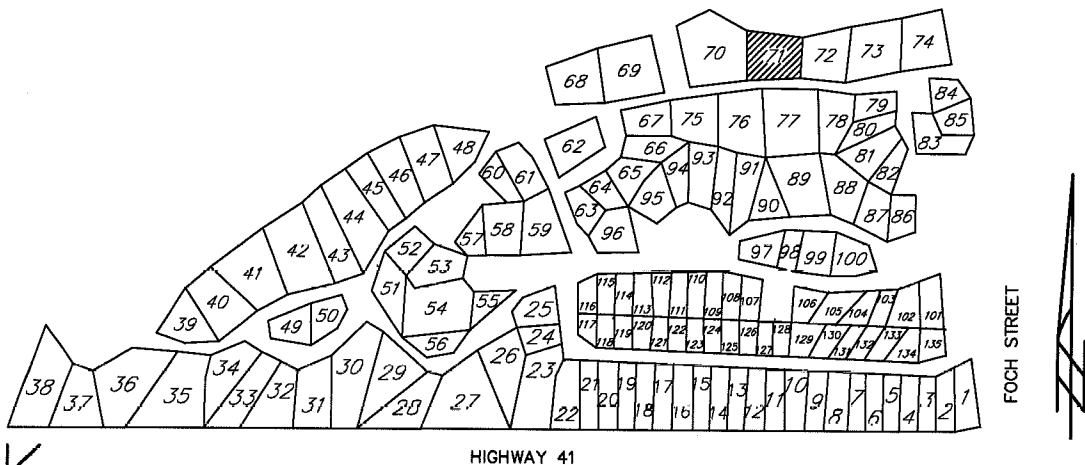

### LEGEND

- Light Pole
- ⊙ Septic Tank Lid
- ⊗ Water Valve
- Electrical Outlet
- ⊡ Telephone Pedestal
- ◆ 0.013 X 0.450 m small Iron post

### KEY PLAN

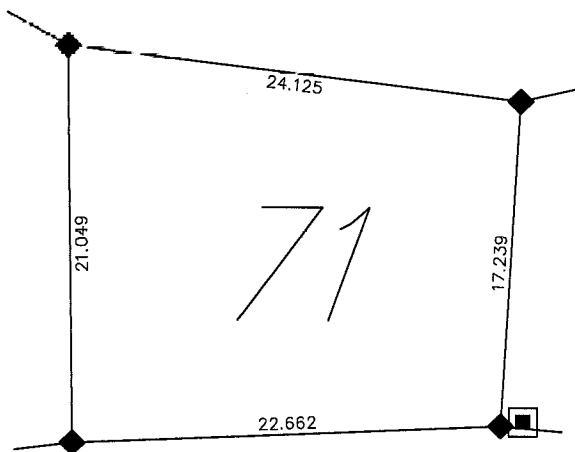

<b>AREA</b>	
sq. m. =	445.96
sq. ft. =	4800.3

SCALE  
1:400

PREPARED BY:



07-1622cs B.J.F.

# POPLAR BEACH



## R. V. RESORT

WAKAW LAKE, SASK.

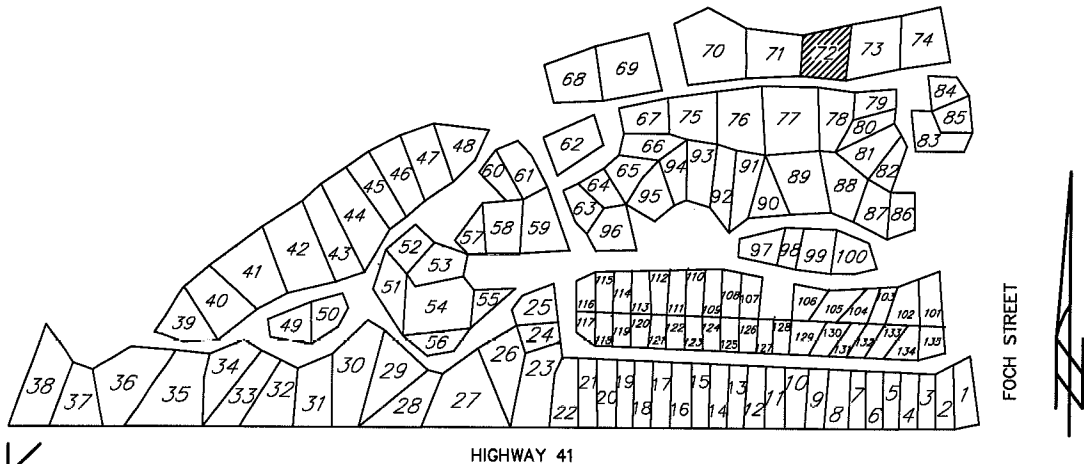

KEY PLAN

HIGHWAY 41

FOCH STREET

**LEGEND**

- Light Pole
- ⊙ Septic Tank Lid
- ⊗ Water Valve
- Electrical Outlet
- Ⓟ Telephone Pedestal
- ◆ 0.013 X 0.450 m small iron post

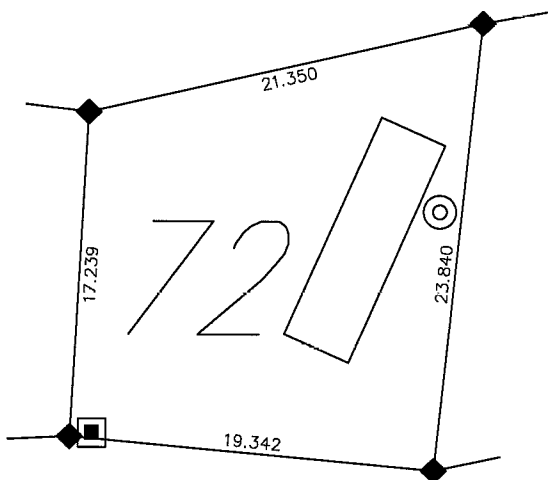

**AREA**  
 sq. m. = 407.40  
 sq. ft. = 4385.2

SCALE  
 1:400

PREPARED BY:



07-1622cs BJB



# POPLAR BEACH



## R.V. RESORT

WAKAW LAKE, SASK.

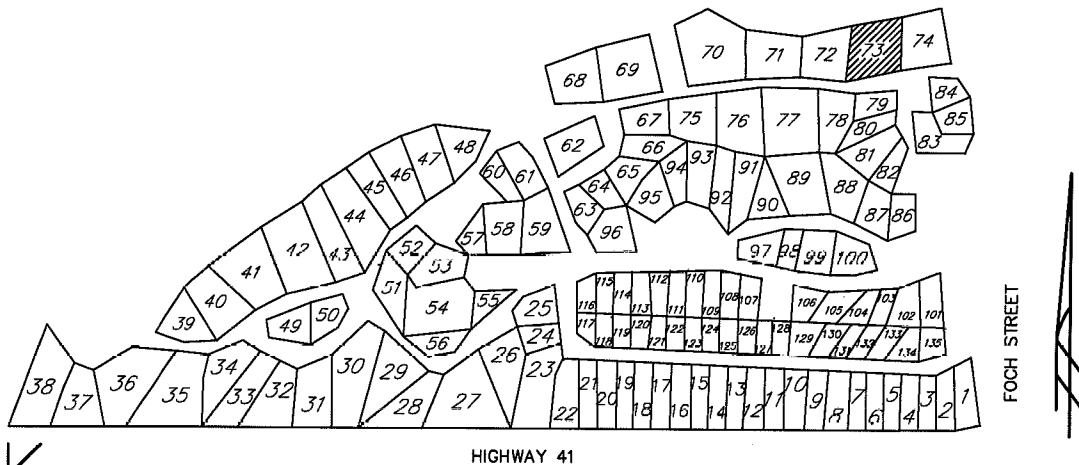

### LEGEND

- Light Pole
- ⊙ Septic Tank Lid
- ⊗ Water Valve
- Electrical Outlet
- Ⓟ Telephone Pedestal
- ◆ 0.013 X 0.450 m small iron post

### KEY PLAN

HIGHWAY 41

FOCH STREET

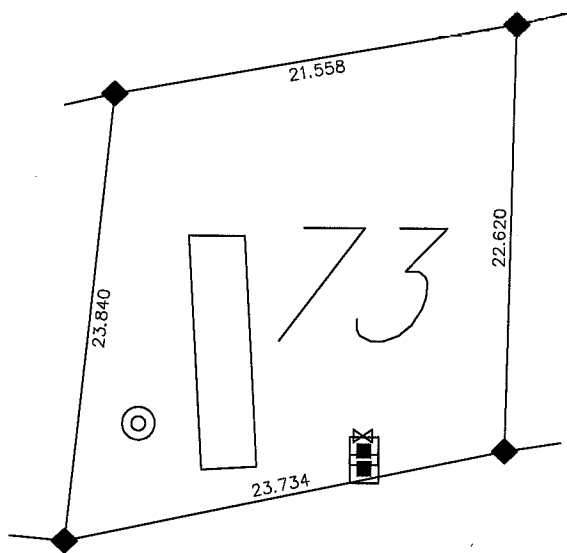

**AREA**  
 sq. m. = 508.39  
 sq. ft. = 5472.3

SCALE  
 1:400

PREPARED BY:

*Webb Surveys*

07-1622cs B/J

# POPLAR BEACH



## R.V. RESORT

WAKAW LAKE, SASK.

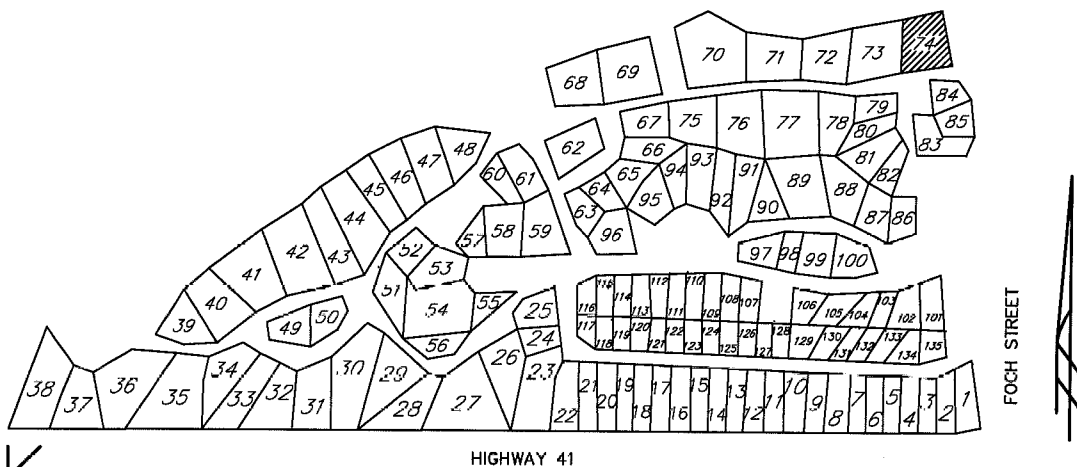

### KEY PLAN

HIGHWAY 41

FOCH STREET

#### LEGEND

- Light Pole
- Septic Tank Lid
- ⊗ Water Valve
- Electrical Outlet
- P Telephone Pedestal
- ◆ 0.013 X 0.450 m small iron post

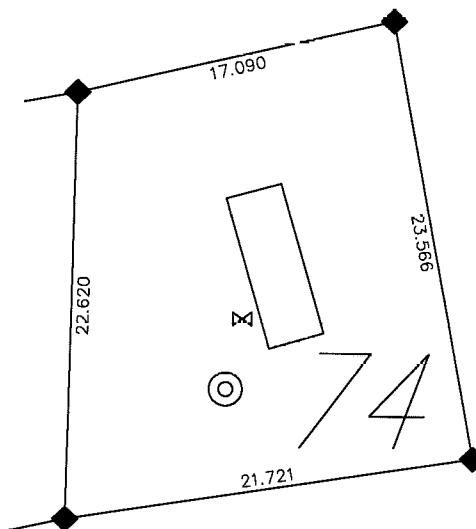

AREA	
sq. m.	= 443.18
sq. ft.	= 4770.3

SCALE  
1: 400

PREPARED BY:

Webb Surveys

07-1622cs B.J.F.

# POPLAR BEACH

## R.V. RESORT

WAKAW LAKE, SASK.

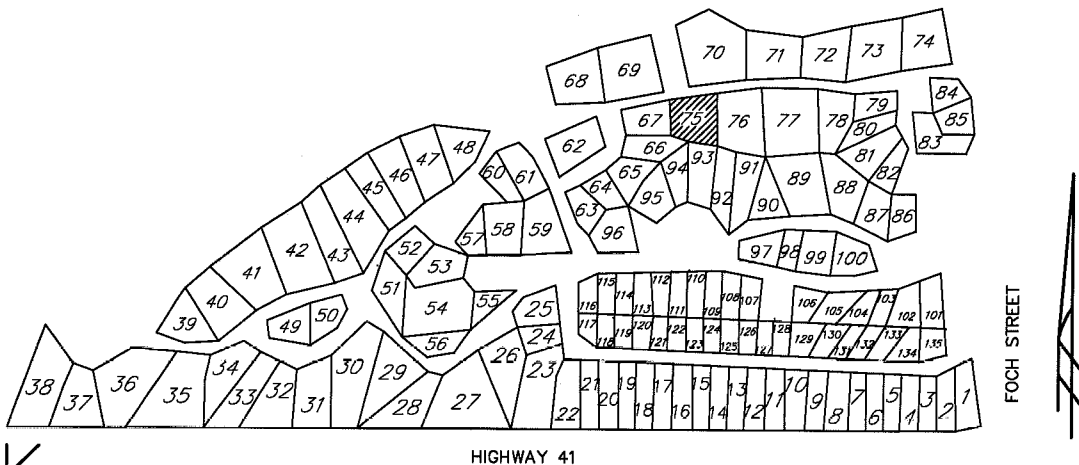

### LEGEND

- Light Pole
- Septic Tank Lid
- ⊗ Water Valve
- Electrical Outlet
- Telephone Pedestal
- ◆ 0.013 X 0.450 m small iron post

### KEY PLAN

HIGHWAY 41

FOCH STREET

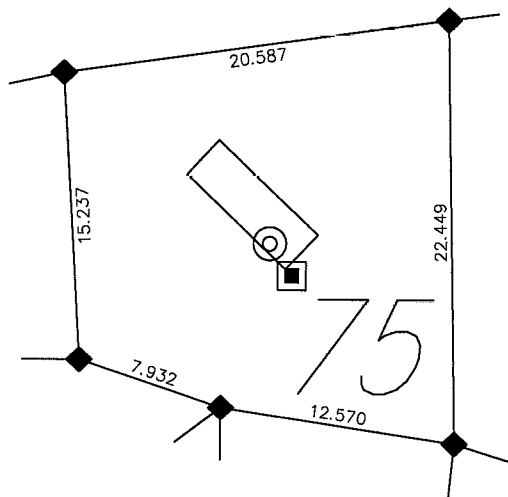

**AREA**  
 sq. m. = 387.86  
 sq. ft. = 4174.9

SCALE  
 1:400

PREPARED BY:

*Webb Surveys*

07-1622cs B/J

# POPLAR BEACH



## R. V. RESORT

WAKAW LAKE, SASK.

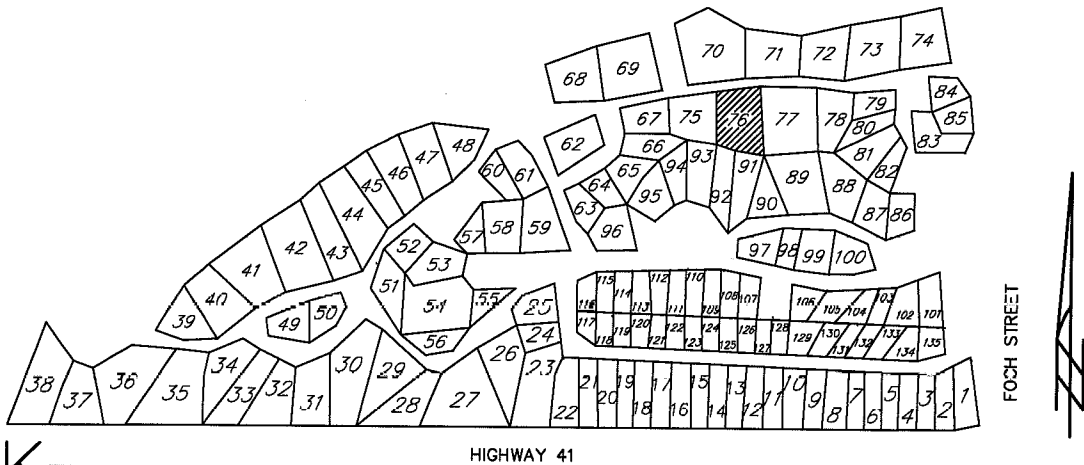

### LEGEND

- Light Pole
- Septic Tank Lid
- ⊗ Water Valve
- Electrical Outlet
- Ⓟ Telephone Pedestal
- ◆ 0.013 X 0.450 m small iron post

### KEY PLAN

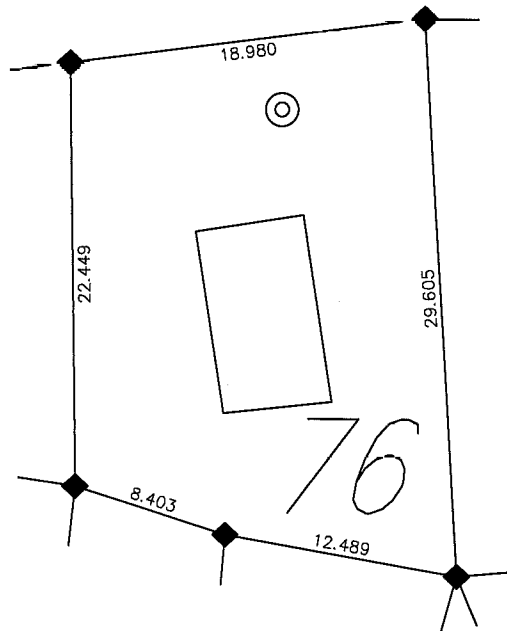

AREA	
sq. m.	= 514.44
sq. ft.	= 5537.4

SCALE  
1:400

PREPARED BY:

**Webb Surveys**

07-1622cs B/J

# POPLAR BEACH



## R.V. RESORT

WAKAW LAKE, SASK.

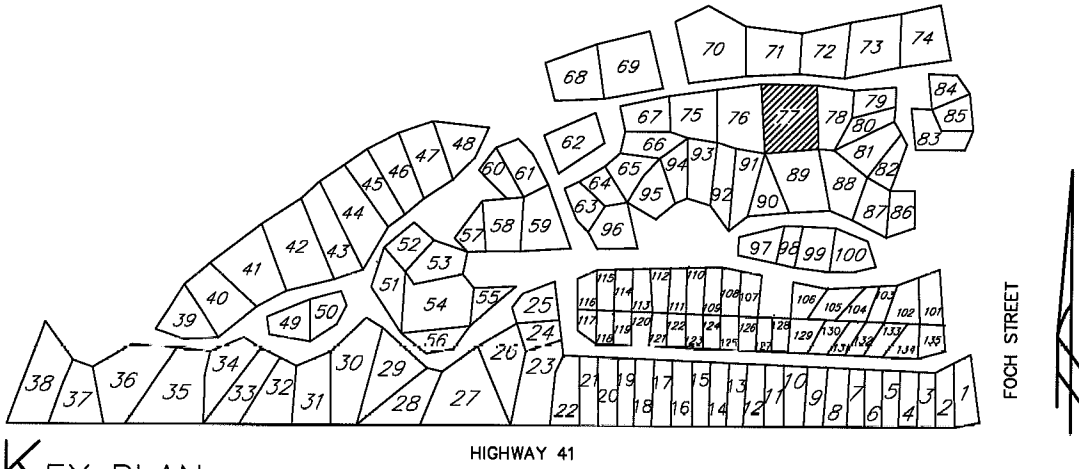

### LEGEND

- Light Pole
- ⊙ Septic Tank Lid
- ⊗ Water Valve
- Electrical Outlet
- P Telephone Pedestal
- ◆ 0.013 X 0.450 m small iron post

### KEY PLAN

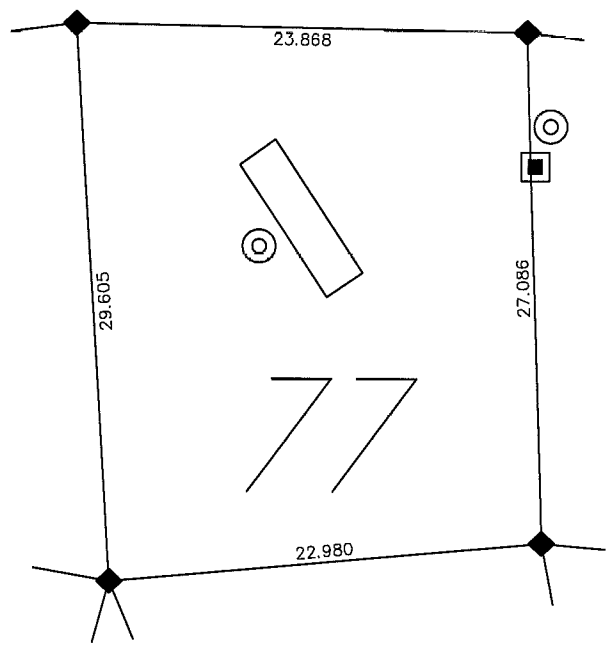

**AREA**  
 sq. m. = 662.88  
 sq. ft. = 7135.2

SCALE  
 1:400

PREPARED BY:  
  
**Webb Surveys**  
 07-1622cs B.J.F.

# POPLAR BEACH



## R.V. RESORT

WAKAW LAKE, SASK.

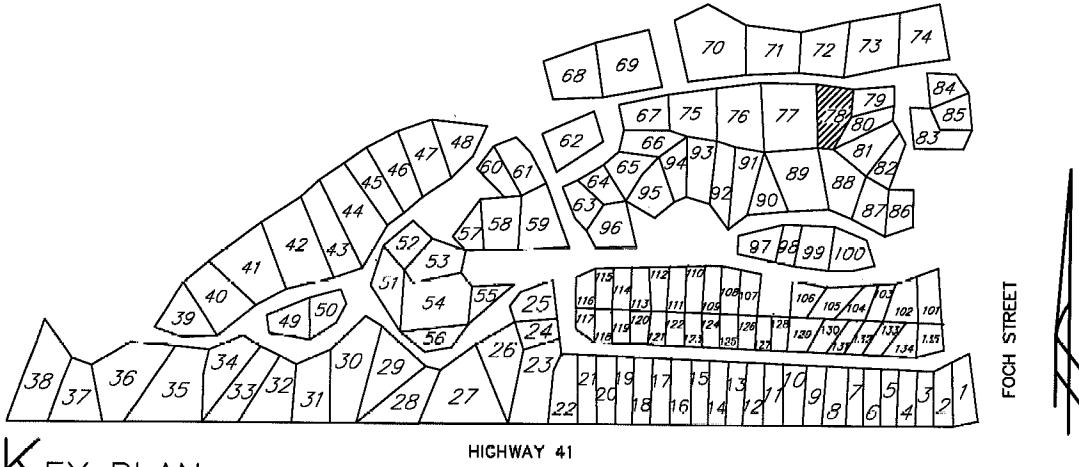

KEY PLAN

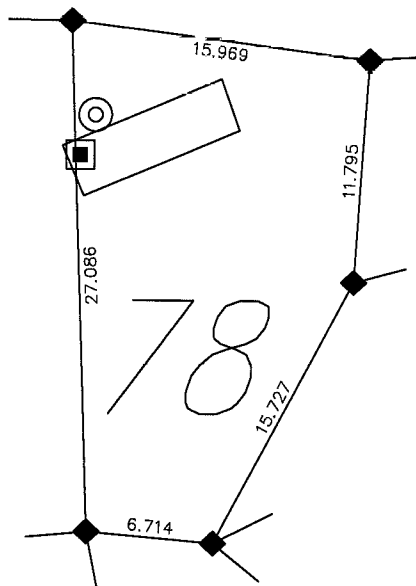

**AREA**  
 sq. m. = 339.83  
 sq. ft. = 3657.9

SCALE  
 1:400

PREPARED BY:  
  
**Webb Surveys**  
 07-1622cs B/J

# POPLAR BEACH



## R.V. RESORT

WAKAW LAKE, SASK.

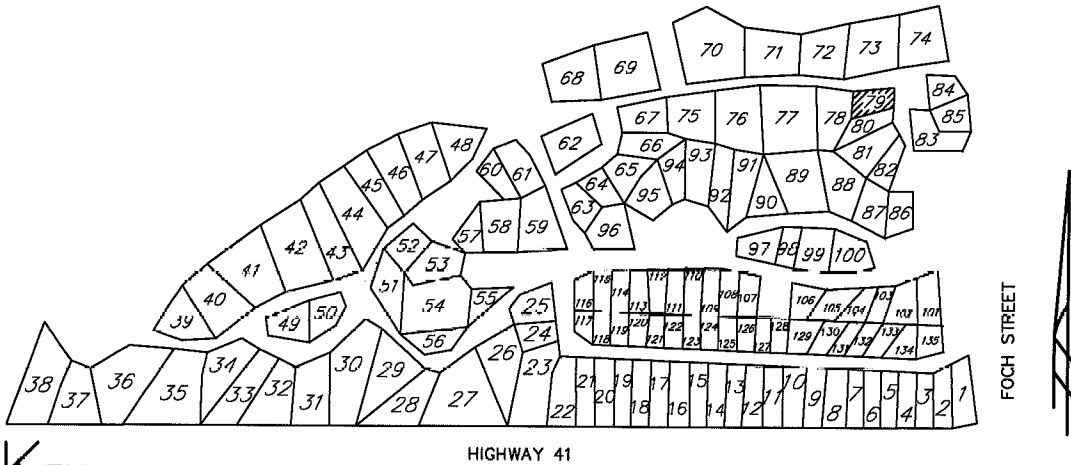

KEY PLAN

### LEGEND

- Light Pole
- ⊙ Septic Tank Lid
- ⊠ Water Valve
- Electrical Outlet
- P Telephone Pedestal
- ◆ 0.013 X 0.450 m small iron post

AREA	
sq. m.	= 178.26
sq. ft.	= 1918.8

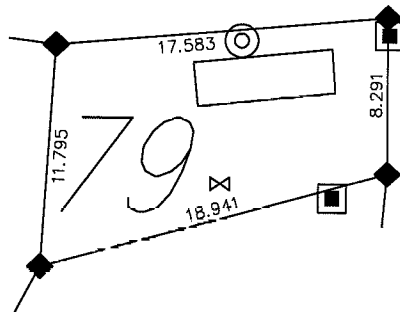

SCALE  
1:400

PREPARED BY:

*Webb Surveys*

07-1622cs B.J.F.

# POPLAR BEACH



## R.V. RESORT

WAKAW LAKE, SASK.

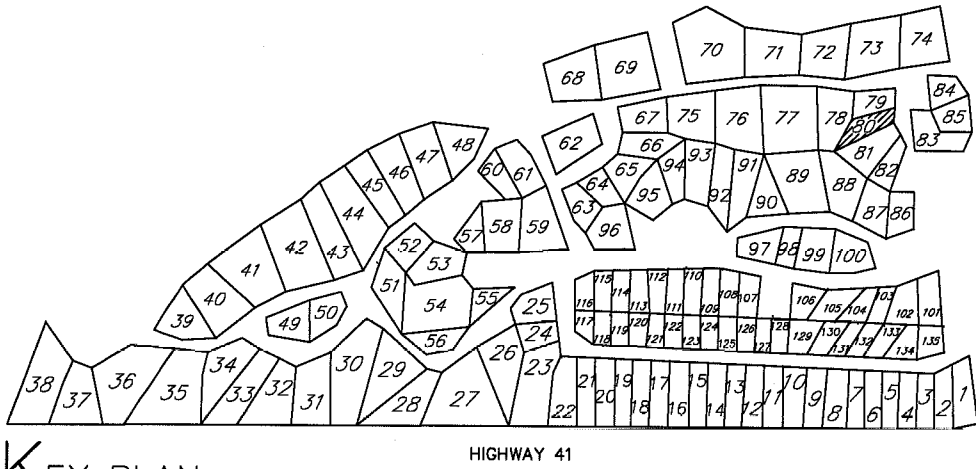

### LEGEND

- Light Pole
- Septic Tank Lid
- ⊗ Water Valve
- Electrical Outlet
- Telephone Pedestal
- ◆ 0.013 X 0.450 m small iron post

### KEY PLAN

HIGHWAY 41

FOCH STREET

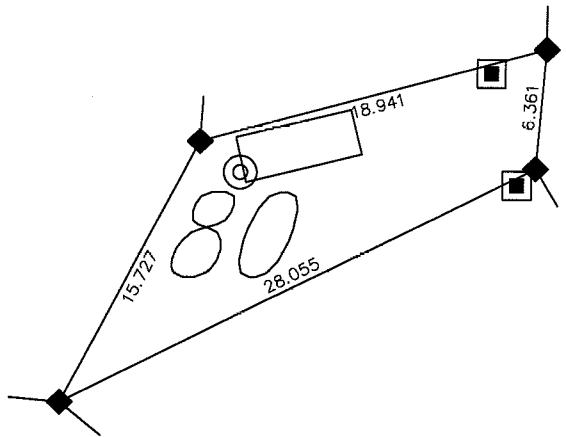

**AREA**  
 sq. m. = 184.33  
 sq. ft. = 1984.1

SCALE  
 1:400

PREPARED BY:

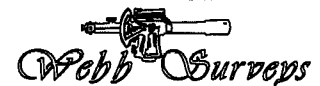

07-1622cs B/J



# POPLAR BEACH



## R.V. RESORT

WAKAW LAKE, SASK.

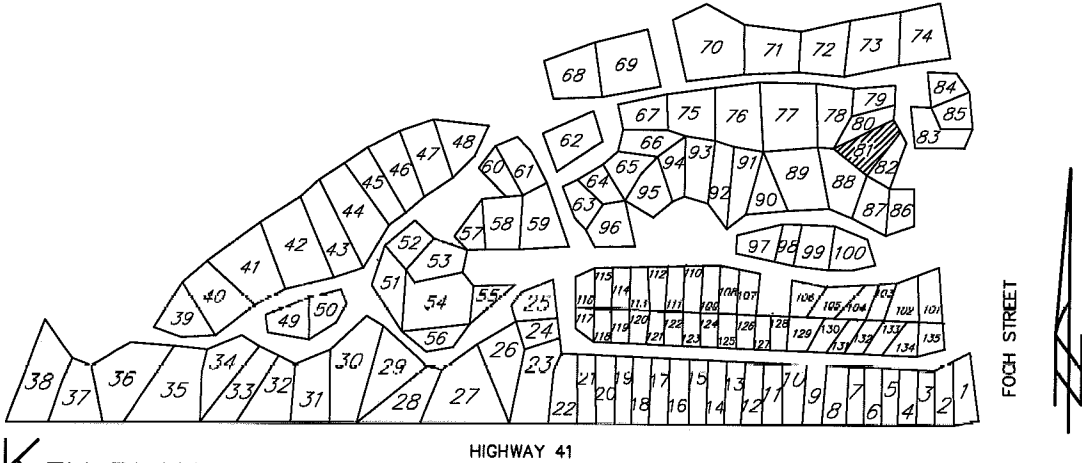

### LEGEND

- Light Pole
- Septic Tank Lid
- ⊗ Water Valve
- Electrical Outlet
- Telephone Pedestal
- ◆ 0.013 X 0.450 m small iron post

### KEY PLAN

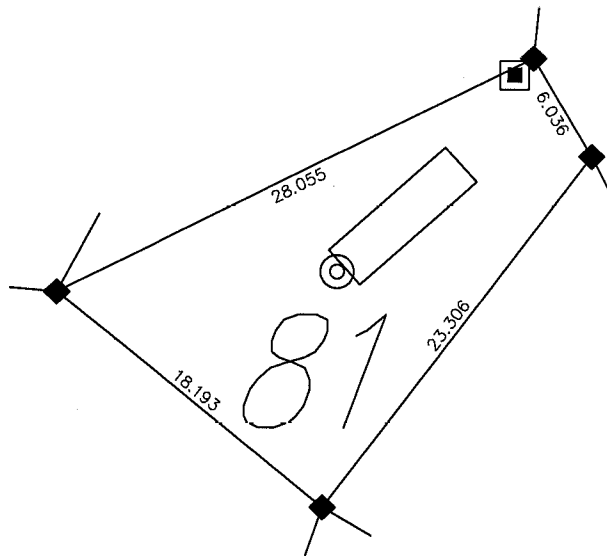

AREA	
sq. m.	= 296.34
sq. ft.	= 3189.8

SCALE  
1:400

PREPARED BY:

Webb Surveys

07-1622cs B/J

# POPLAR BEACH



## R.V. RESORT

WAKAW LAKE, SASK.

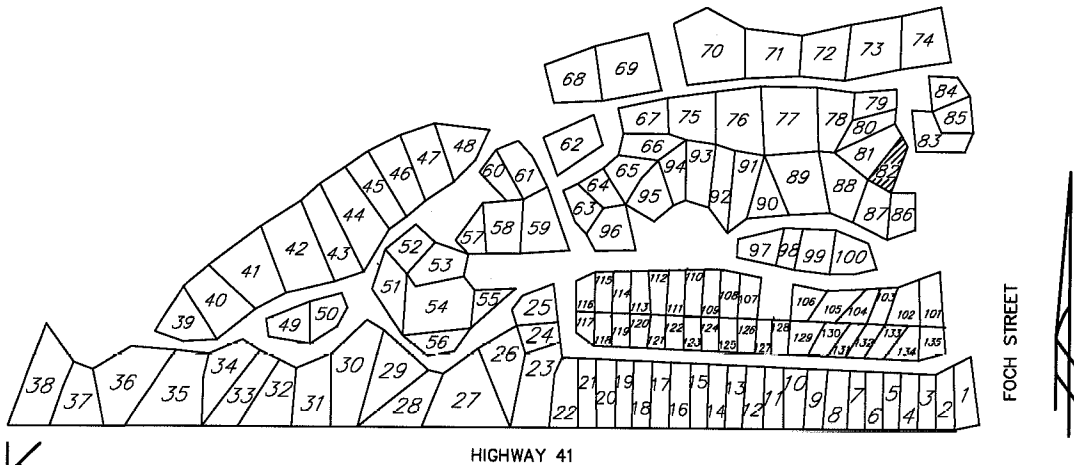

### LEGEND

- Light Pole
- Septic Tank Lid
- ⊗ Water Valve
- Electrical Outlet
- Telephone Pedestal
- ◆ 0.013 X 0.450 m small iron post

### KEY PLAN

HIGHWAY 41

FOCH STREET

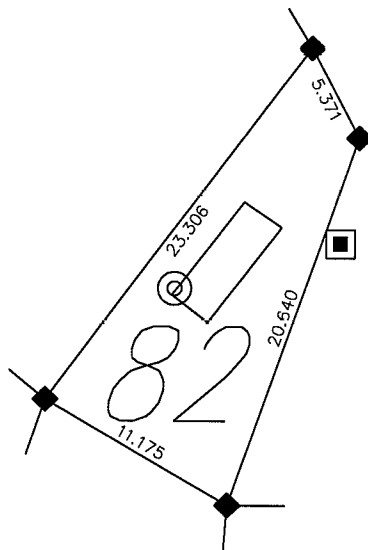

AREA	
sq. m.	= 169.94
sq. ft.	= 1829.2

SCALE  
1: 400

PREPARED BY:

Webb Surveys

07-1622cs B.J.F.

# POPLAR BEACH



## R.V. RESORT

WAKAW LAKE, SASK.

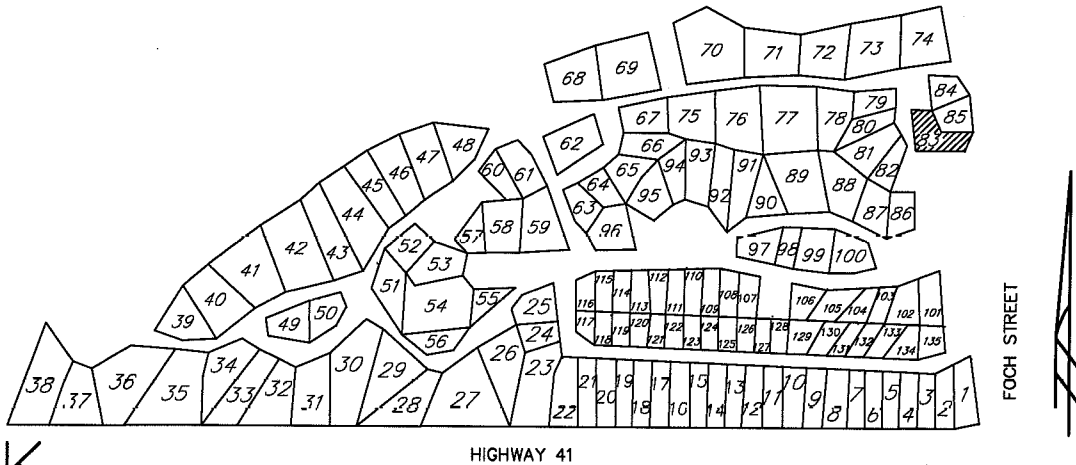

### KEY PLAN

#### LEGEND

- Light Pole
- Septic Tank Lid
- ⊗ Water Valve
- Electrical Outlet
- Telephone Pedestal
- ◆ 0.013 X 0.450 m small iron post

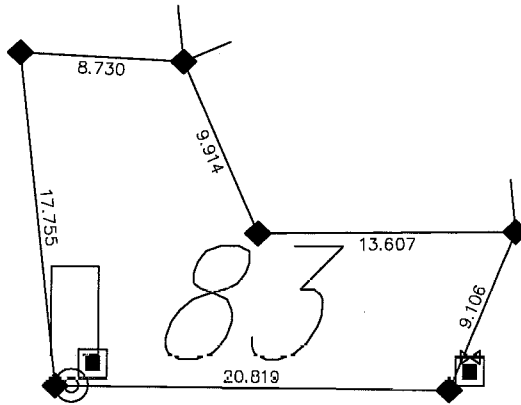

AREA	
sq. m.	= 283.34
sq. ft.	= 3049.9

SCALE  
1:400

PREPARED BY:  
  
**Webb Surveys**

07-1622cs B/JF

# POPLAR BEACH



## R. V. RESORT

WAKAW LAKE, SASK.

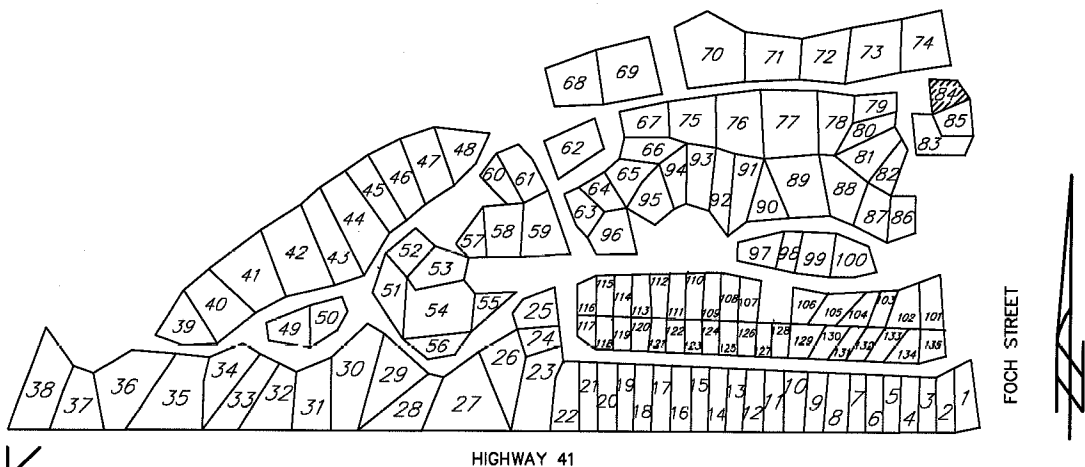

### LEGEND

- Light Pole
- Septic Tank Lid
- ⊗ Water Valve
- Electrical Outlet
- Telephone Pedestal
- ◆ 0.013 X 0.450 m small iron post

### KEY PLAN

HIGHWAY 41

FOCH STREET

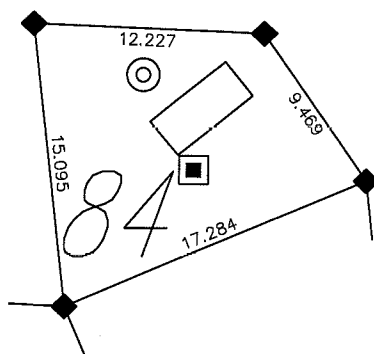

AREA	
sq. m.	= 171.32
sq. ft.	= 1844.1

SCALE  
1:400

PREPARED BY:

**Webb Surveys**

07-1622cs B.J.F.

# POPLAR BEACH

## R.V. RESORT

WAKAW LAKE, SASK.

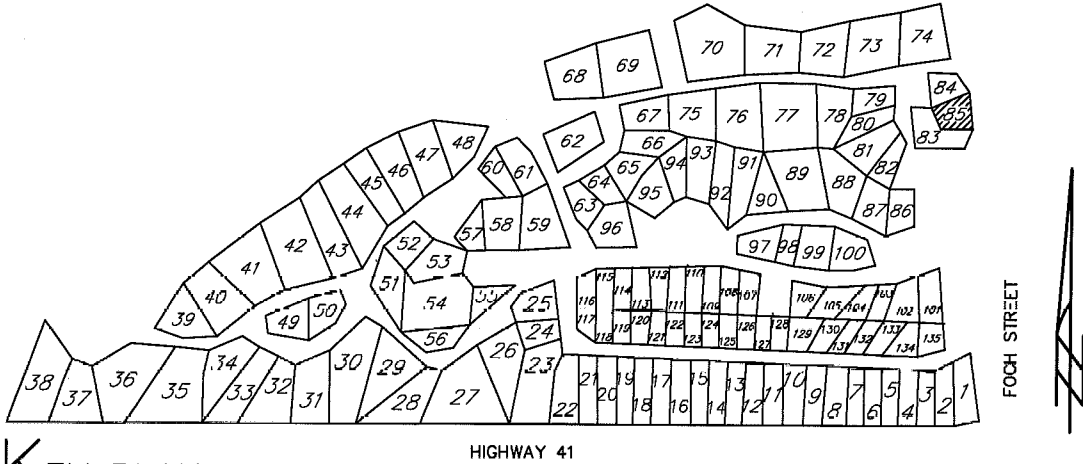

### KEY PLAN

#### LEGEND

- Light Pole
- Septic Tank Lid
- ⊗ Water Valve
- Electrical Outlet
- Telephone Pedestal
- ◆ 0.013 X 0.450 m small iron post

HIGHWAY 41

FOCH STREET

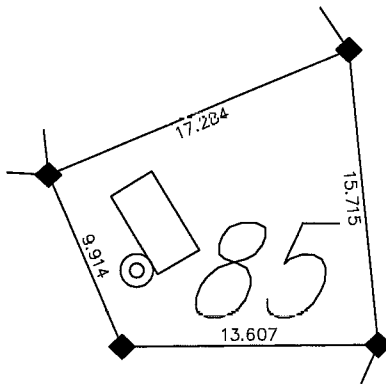

AREA	
sq. m.	= 192.12
sq. ft.	= 2068.0

SCALE  
1:400

PREPARED BY:

*Webb Surveys*

07-1622cs B/J

# POPLAR BEACH



## R. V. RESORT

WAKAW LAKE, SASK.

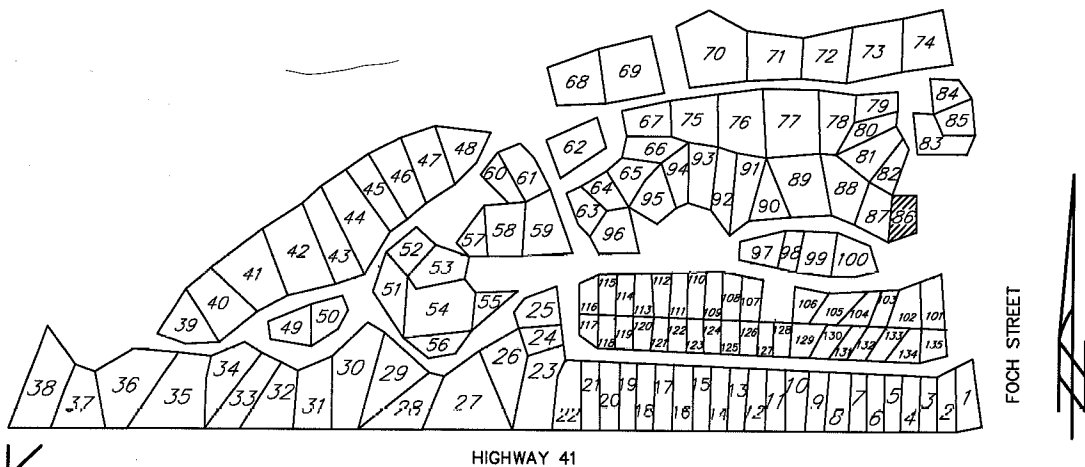

KEY PLAN

HIGHWAY 41

FOCH STREET

### LEGEND

- Light Pole
- ⊙ Septic Tank Lid
- ⊗ Water Valve
- Electrical Outlet
- Ⓟ Telephone Pedestal
- ◆ 0.013 X 0.450 m small iron post

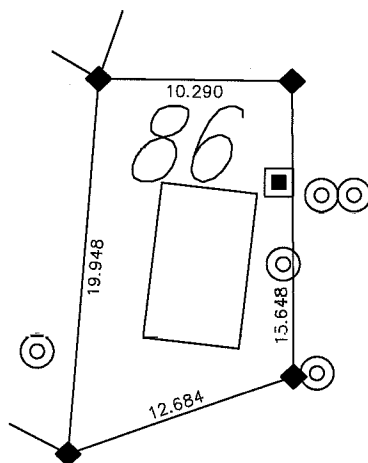

AREA	
sq. m.	= 196.48
sq. ft.	= 2114.9

SCALE  
1:400

PREPARED BY:

Webb Surveys

07-1622cs BJJ

# POPLAR BEACH



## R. V. RESORT

WAKAW LAKE, SASK.

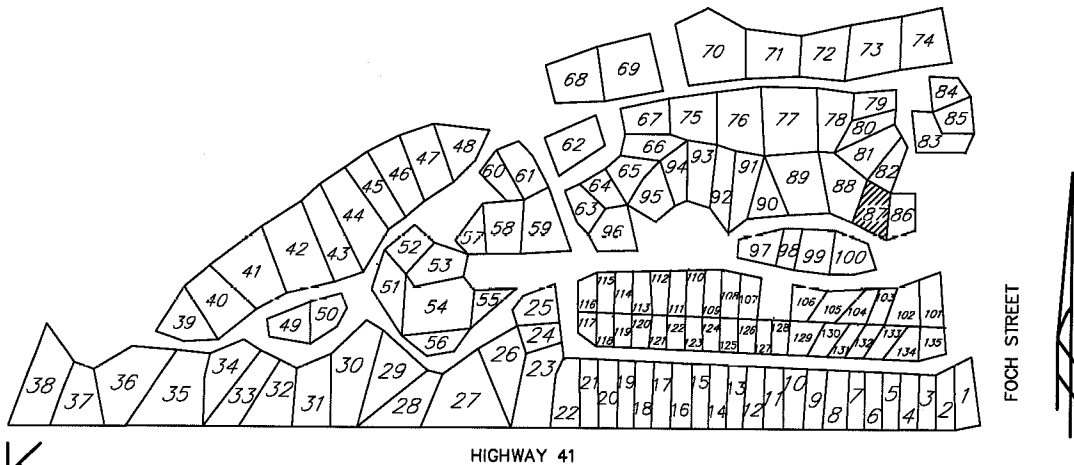

### LEGEND

- Light Pole
- Septic Tank Lid
- ⊗ Water Valve
- Electrical Outlet
- Telephone Pedestal
- ◆ 0.013 X 0.450 m small iron post

### KEY PLAN

HIGHWAY 41

FOCH STREET

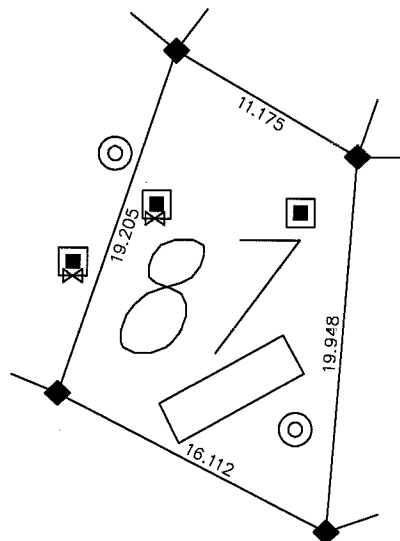

**AREA**  
 sq. m. = 253.60  
 sq. ft. = 2729.7

SCALE  
 1:400

PREPARED BY:

**Webb Surveys**

07-1622cs B.J.F.

# POPLAR BEACH



## R. V. RESORT

WAKAW LAKE, SASK.

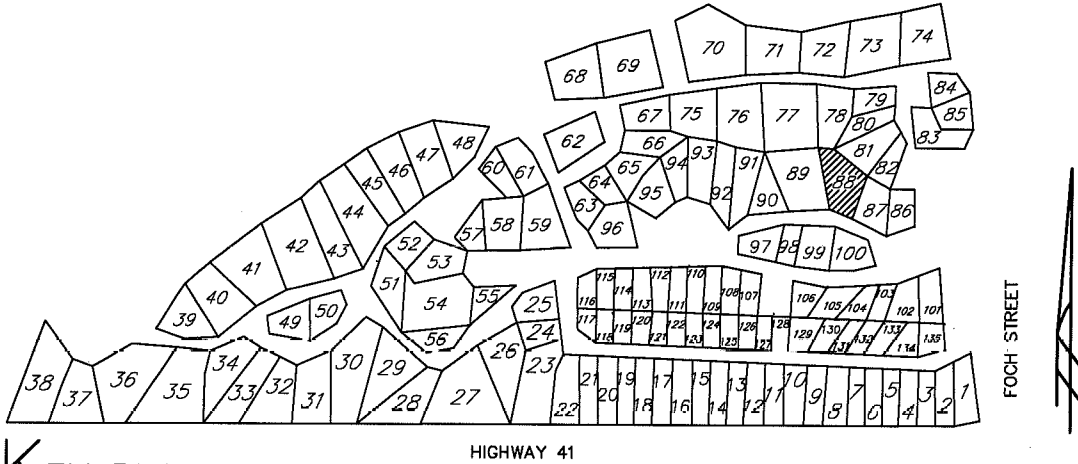

### LEGEND

- Light Pole
- Septic Tank Lid
- ⊗ Water Valve
- Electrical Outlet
- Telephone Pedestal
- ◆ 0.013 X 0.450 m small iron post

### KEY PLAN

HIGHWAY 41

FOCH STREET

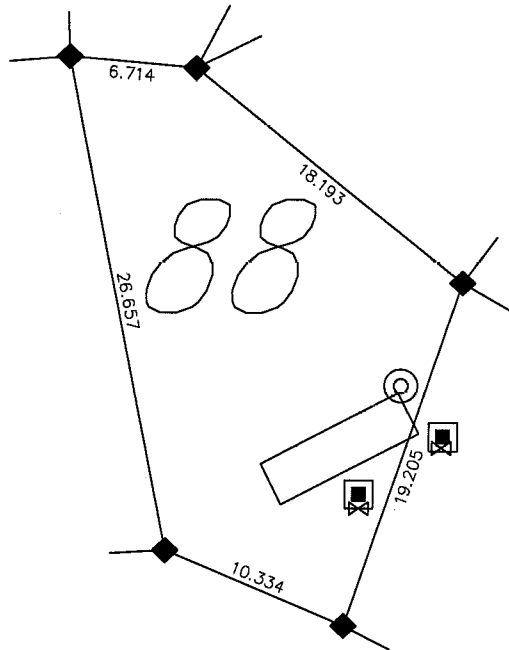

**AREA**  
 sq. m. = 375.13  
 sq. ft. = 4037.9

SCALE  
 1:400

PREPARED BY:  
  
**Webb Surveys**

07-1622cs B/J



# POPLAR BEACH



## R. V. RESORT

WAKAW LAKE, SASK.

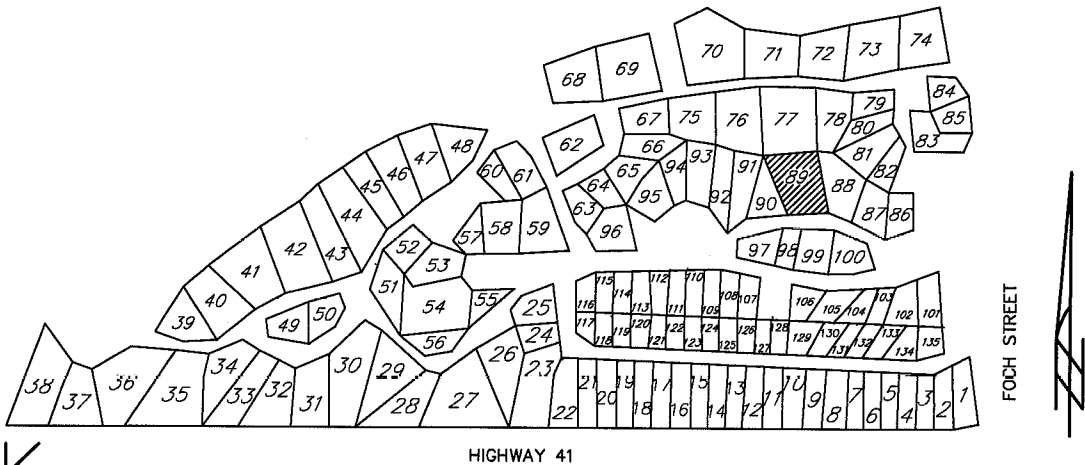

### LEGEND

- Light Pole
- Septic Tank Lid
- ⊗ Water Valve
- Electrical Outlet
- Ⓟ Telephone Pedestal
- ◆ 0.013 X 0.450 m small iron post

### KEY PLAN

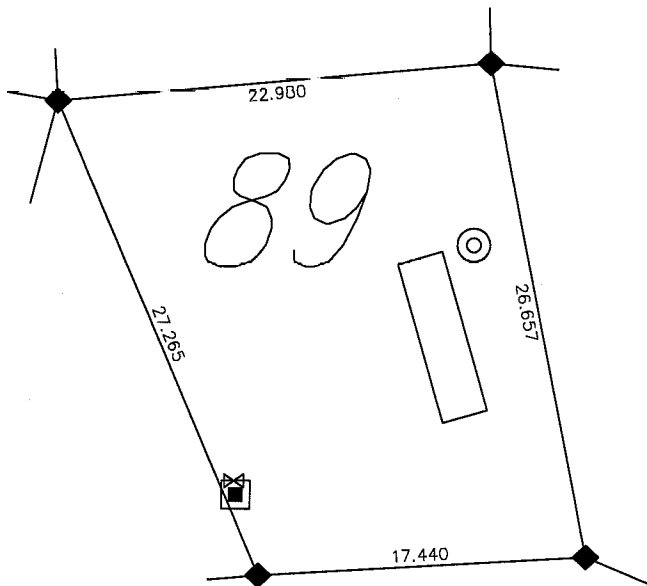

AREA	
sq. m.	= 528.64
sq. ft.	= 5690.2

SCALE  
1:400

PREPARED BY:

*Webb Surveys*

07-1622cs B/J

# POPLAR BEACH



## R.V. RESORT

WAKAW LAKE, SASK.

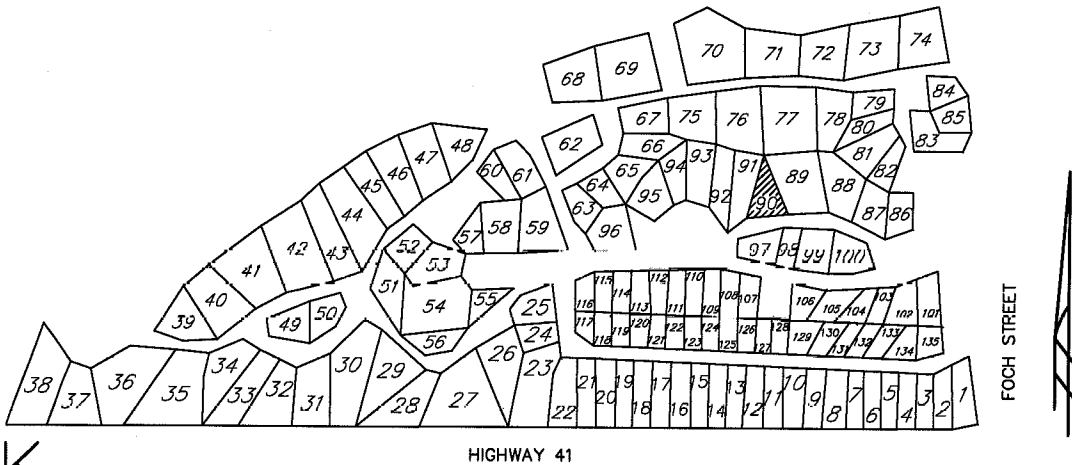

### LEGEND

- Light Pole
- Septic Tank Lid
- ⊗ Water Valve
- Electrical Outlet
- Ⓟ Telephone Pedestal
- ◆ 0.013 X 0.450 m small iron post

### KEY PLAN

HIGHWAY 41

FOCH STREET

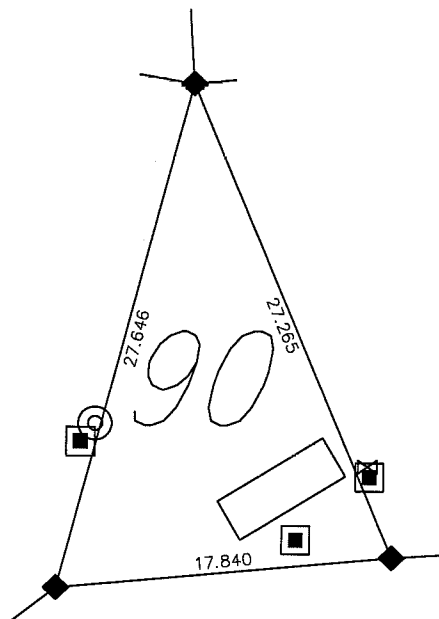

**AREA**  
 sq. m. = 231.57  
 sq. ft. = 2492.6

SCALE  
 1:400

PREPARED BY:

**Webb Surveys**

07-1622cs B/J

# POPLAR BEACH



## R. V. RESORT

WAKAW LAKE, SASK.

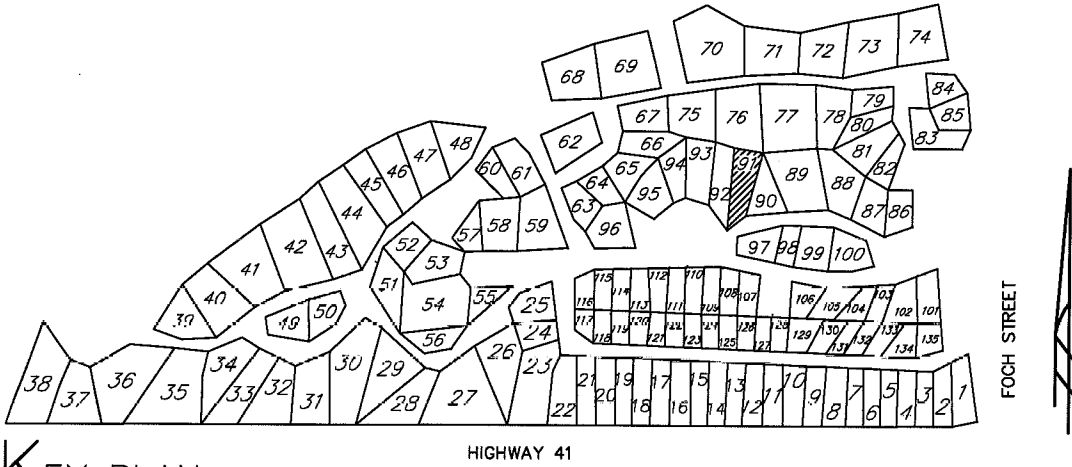

### LEGEND

- Light Pole
- Septic Tank Lid
- ⊗ Water Valve
- Electrical Outlet
- Ⓟ Telephone Pedestal
- ◆ 0.013 X 0.450 m small iron post

### KEY PLAN

HIGHWAY 41

FOCH STREET

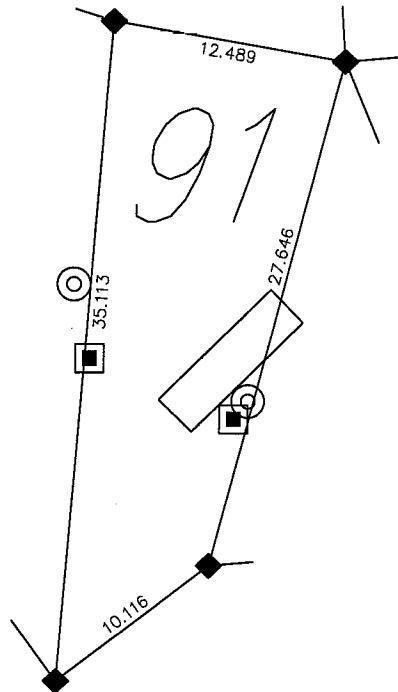

**AREA**  
 sq. m. = 303.69  
 sq. ft. = 3268.9

SCALE  
 1:400

PREPARED BY:

Webb Surveys

07-1622cs B/J

# POPLAR BEACH



## R. V. RESORT

WAKAW LAKE, SASK.

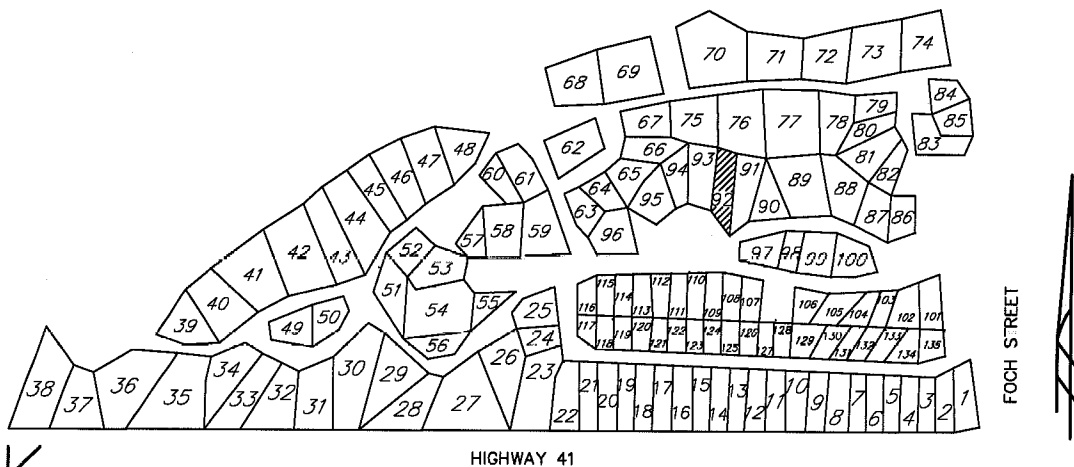

### LEGEND

- Light Pole
- Septic Tank Lid
- ⊗ Water Valve
- Electrical Outlet
- Ⓟ Telephone Pedestal
- ◆ 0.013 X 0.450 m small iron post

### KEY PLAN

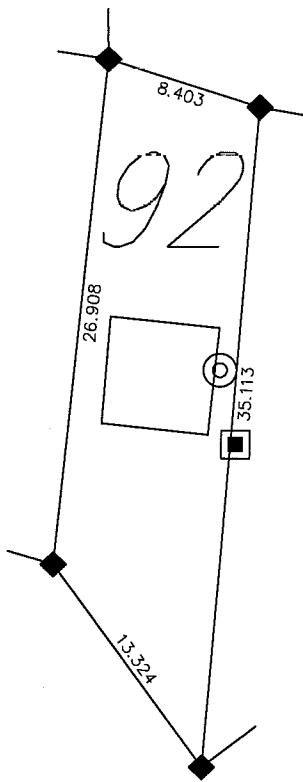

AREA	
sq. m.	= 263.94
sq. ft.	= 2841.0

SCALE  
1: 400

PREPARED BY:

Webb Surveys

07-1622cs BJJ

# POPLAR BEACH



## R.V. RESORT

WAKAW LAKE, SASK.

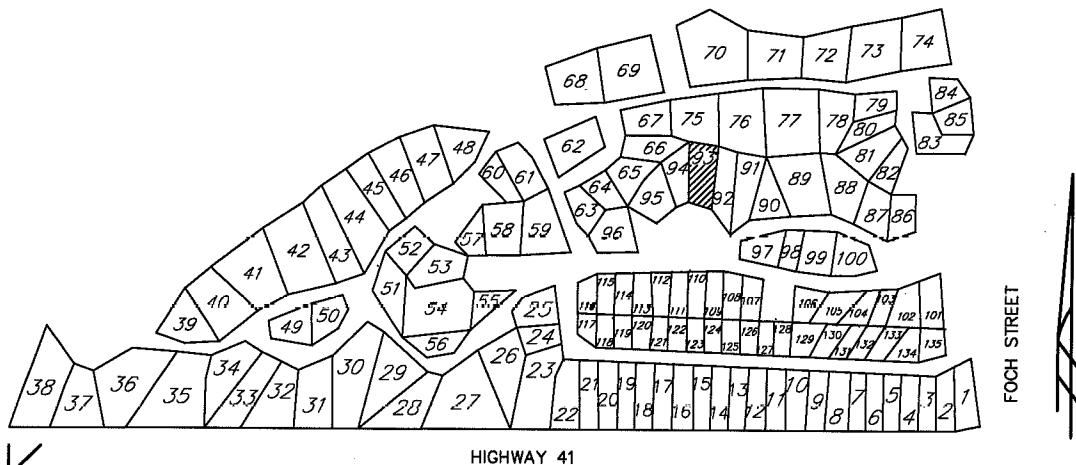

### LEGEND

- Light Pole
- Septic Tank Lid
- ⊗ Water Valve
- Electrical Outlet
- Ⓟ Telephone Pedestal
- ◆ 0.013 X 0.450 m small iron post

### KEY PLAN

HIGHWAY 41

FOCH STREET

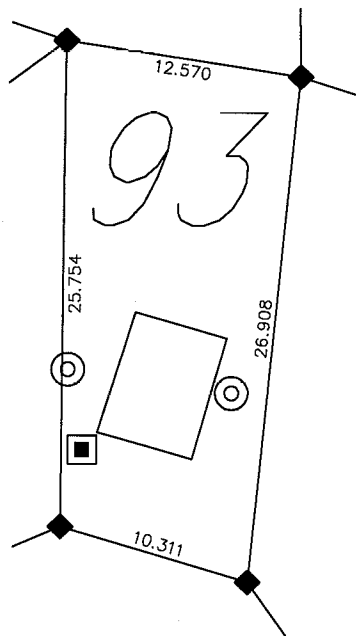

**AREA**  
 sq. m. = 296.54  
 sq. ft. = 3192.0

SCALE  
 1:400

PREPARED BY:

**Webb Surveys**

07-1622cs B.J.F.

# POPLAR BEACH



## R.V. RESORT

WAKAW LAKE, SASK.

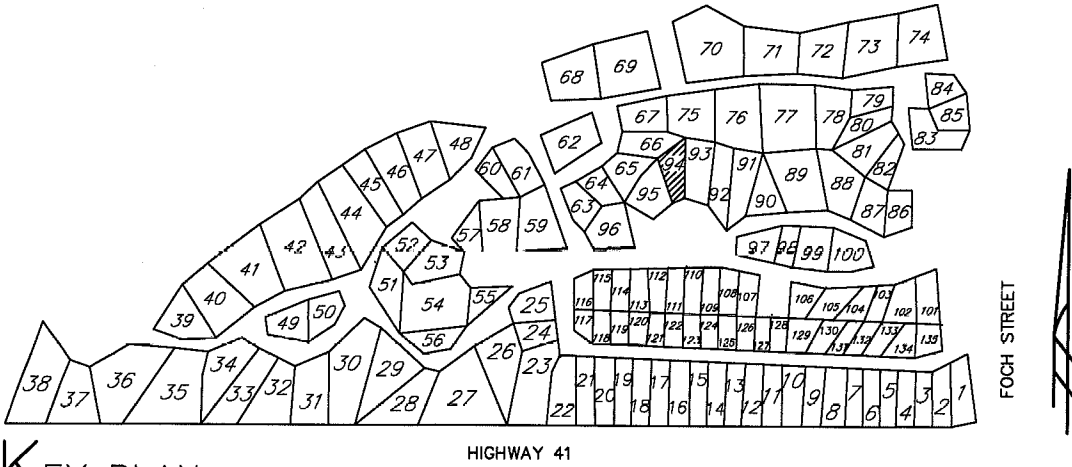

### LEGEND

- Light Pole
- Septic Tank Lid
- ⊗ Water Valve
- Electrical Outlet
- Telephone Pedestal
- ◆ 0.013 X 0.450 m small iron post

### KEY PLAN

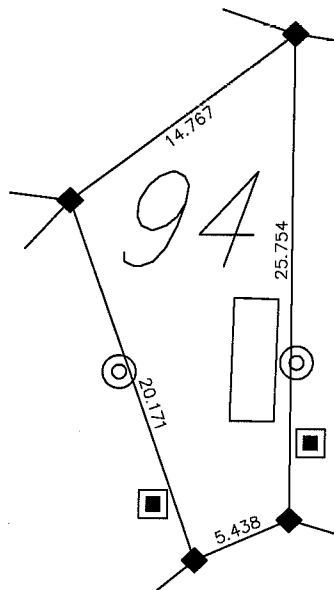

AREA	
sq. m.	= 206.18
sq. ft.	= 2219.3

SCALE  
1:400

PREPARED BY:

Webb Surveys

07-1622cs B/J

# POPLAR BEACH



## R.V. RESORT

WAKAW LAKE, SASK.

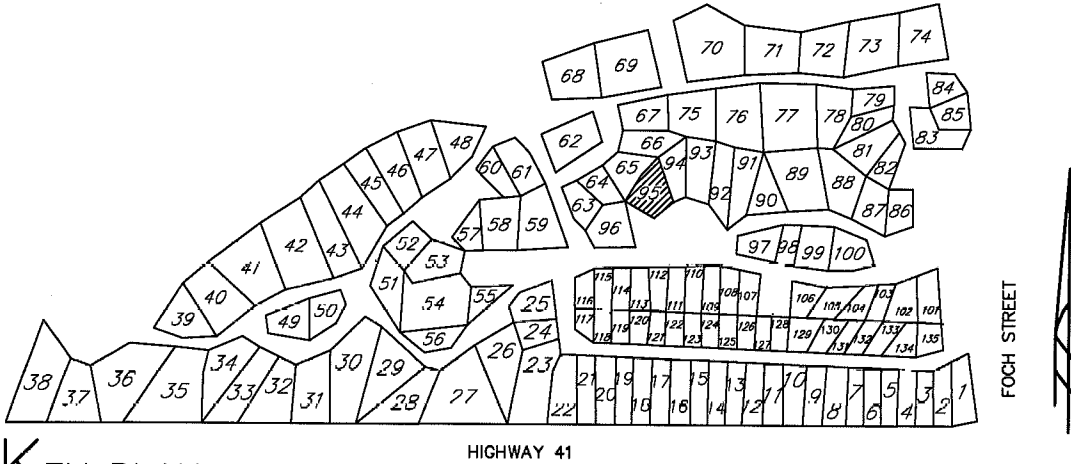

### LEGEND

- Light Pole
- Septic Tank Lid
- ⊗ Water Valve
- Electrical Outlet
- Ⓟ Telephone Pedestal
- ◆ 0.013 X 0.450 m small iron post

### KEY PLAN

HIGHWAY 41

FOCH STREET

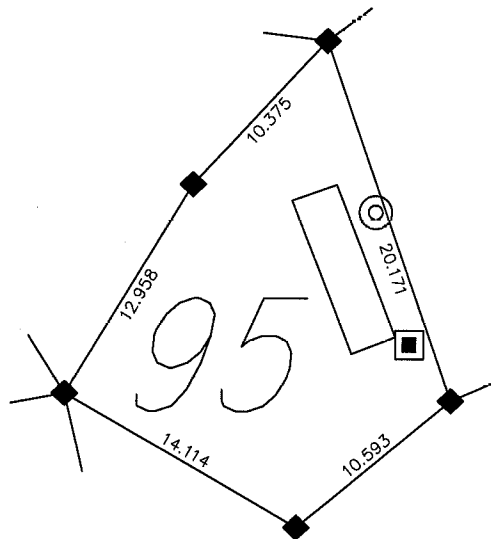

**AREA**  
 sq. m. = 276.74  
 sq. ft. = 2978.8

SCALE  
 1:400

PREPARED BY:

*Webb Surveys*

07-1622cs B/J

# POPLAR BEACH



## R.V. RESORT

WAKAW LAKE, SASK.

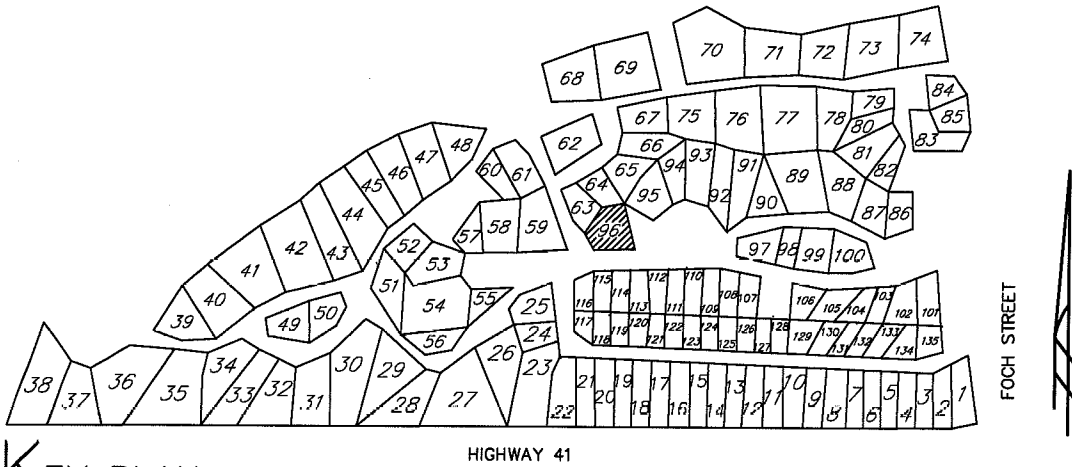

### LEGEND

- Light Pole
- Septic Tank Lid
- ⊗ Water Valve
- Electrical Outlet
- Ⓟ Telephone Pedestal
- ◆ 0.013 X 0.450 m small iron post

### KEY PLAN

HIGHWAY 41

FOCH STREET

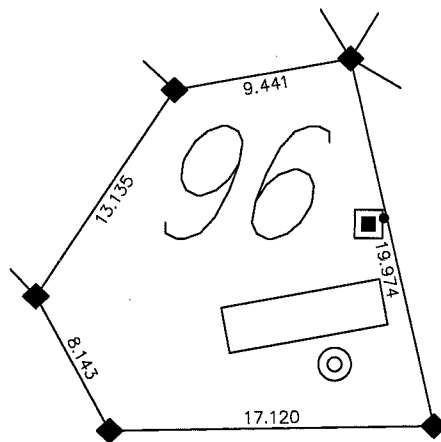

**AREA**  
 sq. m. = 295.77  
 sq. ft. = 3183.6

SCALE  
 1:400

PREPARED BY:

*Webb Surveys*

07-1822cs BJJ



# POPLAR BEACH



## R. V. RESORT

WAKAW LAKE, SASK.

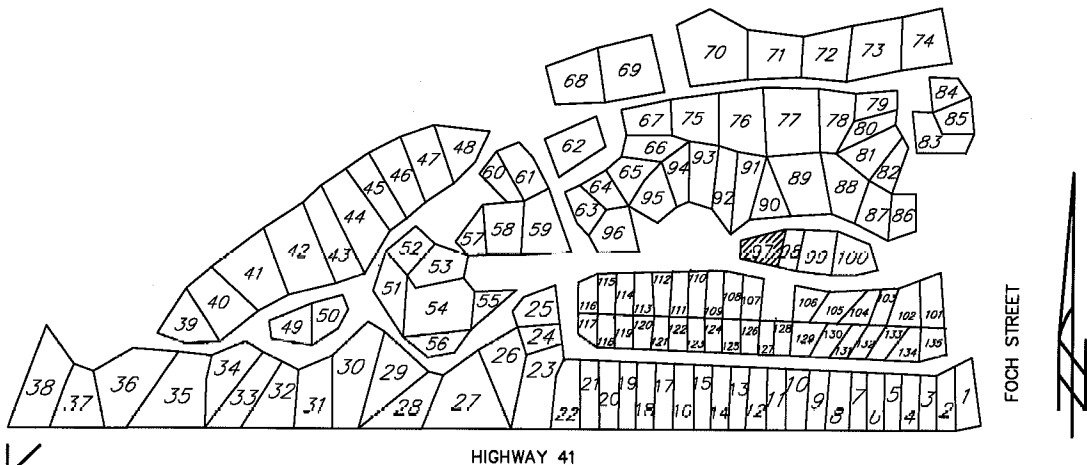

KEY PLAN

HIGHWAY 41

FOCH STREET

### LEGEND

- Light Pole
- Septic Tank Lid
- ⊗ Water Valve
- Electrical Outlet
- Ⓟ Telephone Pedestal
- ◆ 0.013 X 0.450 m small iron post

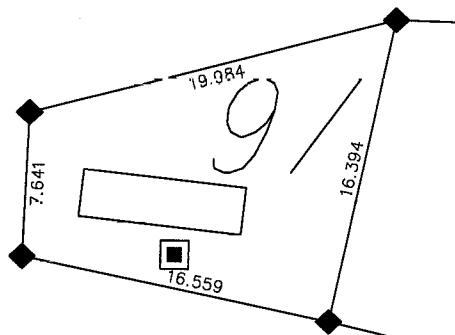

**AREA**  
 sq. m. = 208.68  
 sq. ft. = 2246.2

SCALE  
 1:400

PREPARED BY:

**Webb Surveys**

07-1622cs B/J

# POPLAR BEACH



## R. V. RESORT

WAKAW LAKE, SASK.

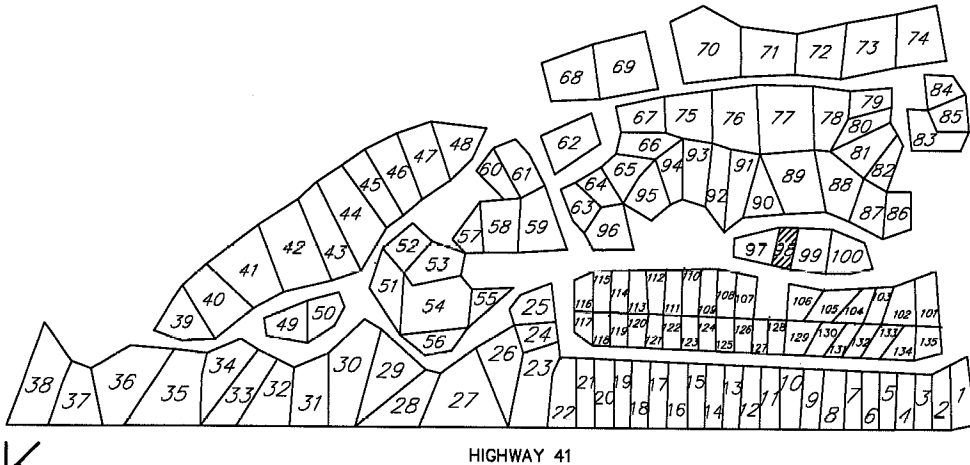

KEY PLAN

### LEGEND

- Light Pole
- Septic Tank Lid
- ⊗ Water Valve
- Electrical Outlet
- Telephone Pedestal
- ◆ 0.013 X 0.450 m small iron post

HIGHWAY 41

FOCH STREET

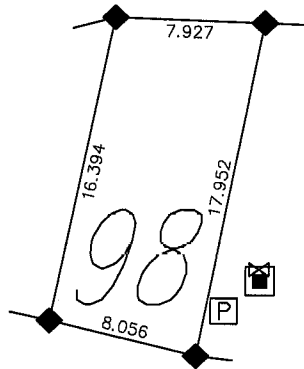

AREA	
sq. m.	= 136.18
sq. ft.	= 1465.8

SCALE  
1: 400

PREPARED BY:  
  
**Webb Surveys**  
 07-1622cs B.J.F.

# POPLAR BEACH

## R.V. RESORT

WAKAW LAKE, SASK.

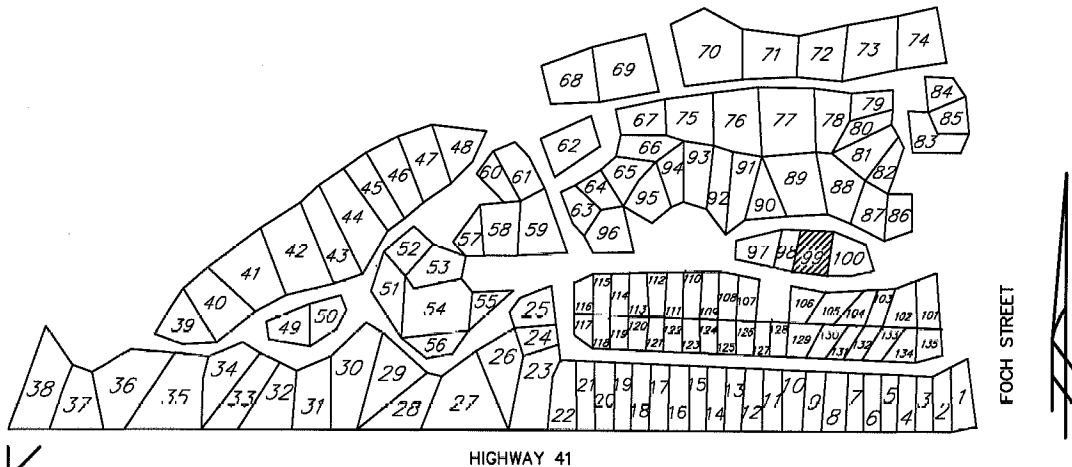

KEY PLAN

### LEGEND

- Light Pole
- Septic Tank Lid
- ⊗ Water Valve
- Electrical Outlet
- Telephone Pedestal
- ◆ 0.013 X 0.450 m small iron post

HIGHWAY 41

FOCH STREET

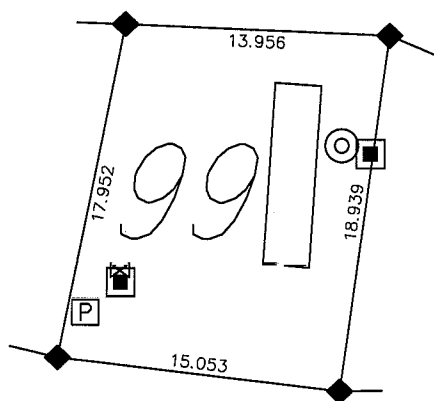

<b>AREA</b>
sq. m. = 266.13
sq. ft. = 2864.6

SCALE  
1: 400

PREPARED BY:  
  
**Webb Surveys**  
 07-1622cs B.J.F.

# POPLAR BEACH



## R.V. RESORT

WAKAW LAKE, SASK.

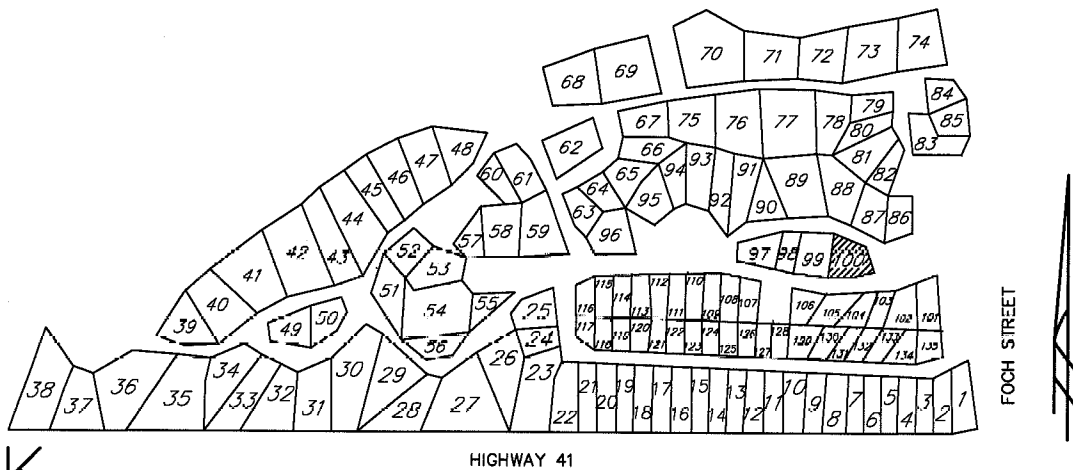

### LEGEND

- Light Pole
- Septic Tank Lid
- ⊗ Water Valve
- Electrical Outlet
- Telephone Pedestal
- ◆ 0.013 X 0.450 m small iron post

### KEY PLAN

HIGHWAY 41

FOCH STREET

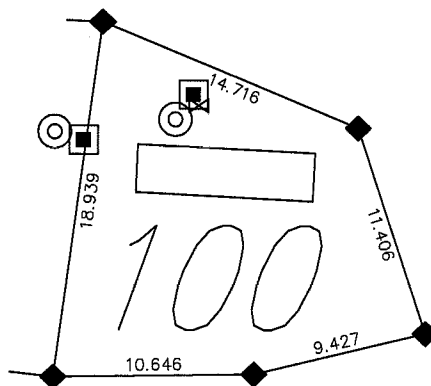

**AREA**  
 sq. m. = 257.23  
 sq. ft. = 2768.8

SCALE  
 1:400

PREPARED BY:  
  
**Webb Surveys**  
 07-1622cs B/J

# POPLAR BEACH



## R.V. RESORT

WAKAW LAKE, SASK.

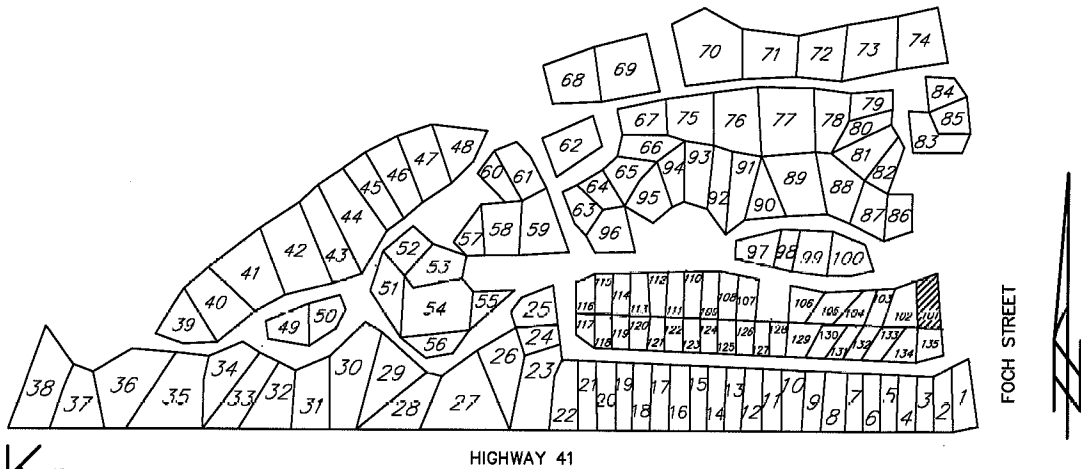

### LEGEND

- Light Pole
- Septic Tank Lid
- ⊗ Water Valve
- Electrical Outlet
- Telephone Pedestal
- ◆ 0.013 X 0.450 m small iron post

### KEY PLAN

HIGHWAY 41

FOCH STREET

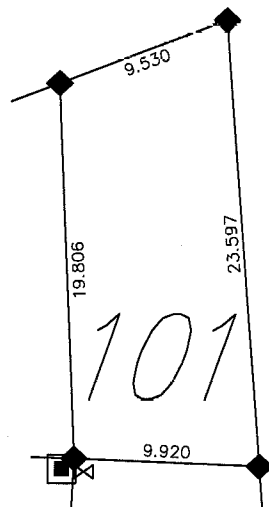

**AREA**  
 sq. m. = 205.84  
 sq. ft. = 2215.7

SCALE  
 1: 400

PREPARED BY:  
  
**Webb Surveys**  
 07-1622cs B.J.F.

# POPLAR BEACH



## R. V. RESORT

WAKAW LAKE, SASK.

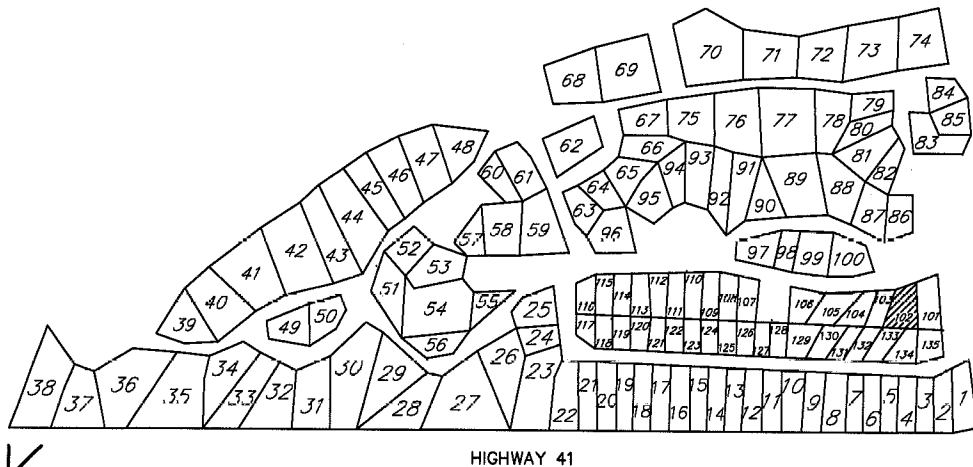

KEY PLAN

### LEGEND

- Light Pole
- Septic Tank Lid
- ⊗ Water Valve
- Electrical Outlet
- Telephone Pedestal
- ◆ 0.013 X 0.450 m small iron post

HIGHWAY 41

FOCH STREET

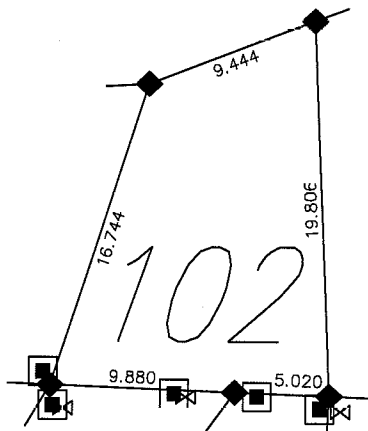

**AREA**  
 sq. m. = 208.56  
 sq. ft. = 2244.9

SCALE  
 1: 400

PREPARED BY:  
  
**Webb Surveys**  
 07-1622cs B.J.F.

# POPLAR BEACH



## R.V. RESORT

WAKAW LAKE, SASK.

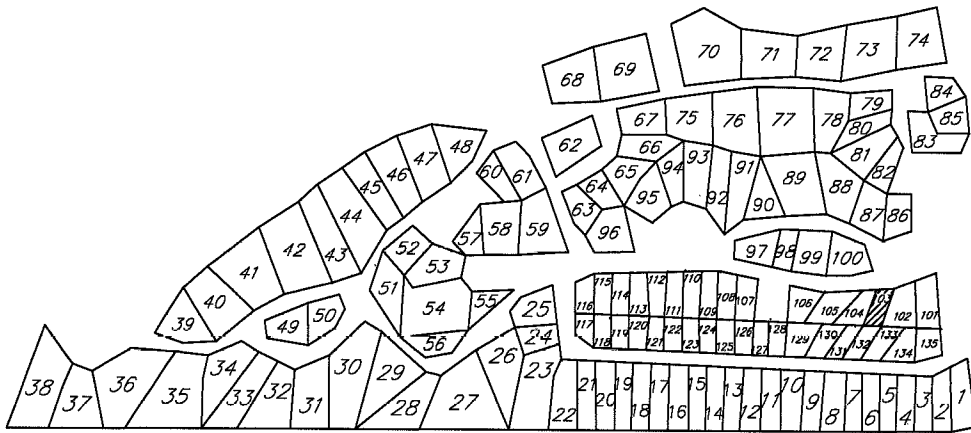

### LEGEND

- Light Pole
- Septic Tank Lid
- ⊗ Water Valve
- Electrical Outlet
- Telephone Pedestal
- ◆ 0.013 X 0.450 m small iron post

### KEY PLAN

HIGHWAY 41

FOCH STREET

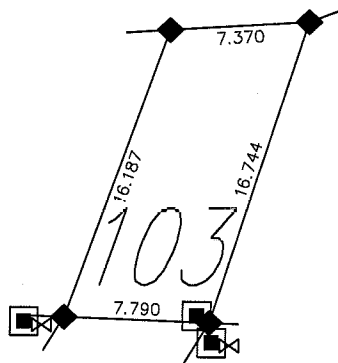

**AREA**  
 sq. m. = 117.10  
 sq. ft. = 1260.4

SCALE  
 1:400

PREPARED BY:  
  
**Webb Surveys**  
 07-1622cs BJJ

# POPLAR BEACH



## R. V. RESORT

WAKAW LAKE, SASK.

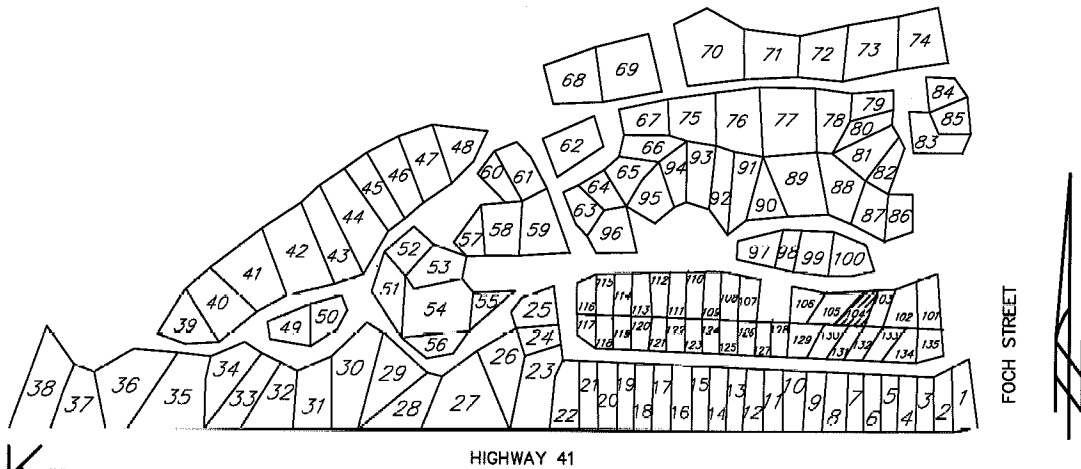

KEY PLAN

### LEGEND

- Light Pole
- Septic Tank Lid
- ⊗ Water Valve
- Electrical Outlet
- Telephone Pedestal
- ◆ 0.013 X 0.450 m small iron post

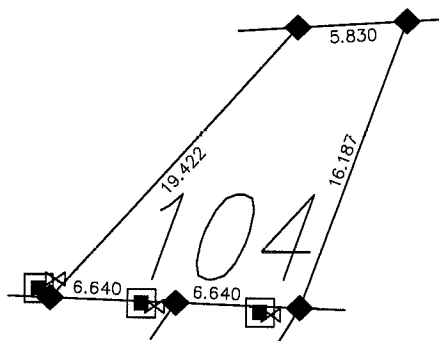

**AREA**  
 sq. m. = 141.24  
 sq. ft. = 1520.3

SCALE  
 1:400

PREPARED BY:  
  
**Webb Surveys**  
 07-1622cs B.J.F.



# POPLAR BEACH



## R.V. RESORT

WAKAW LAKE, SASK.

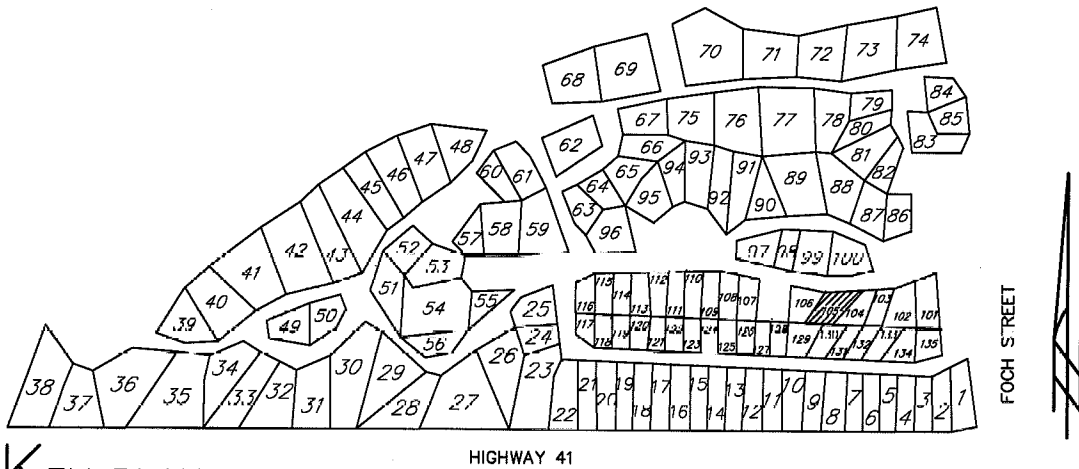

### LEGEND

- Light Pole
- Septic Tank Lid
- ⊗ Water Valve
- Electrical Outlet
- Telephone Pedestal
- ◆ 0.013 X 0.450 m small iron post

### KEY PLAN

HIGHWAY 41

FOCH STREET

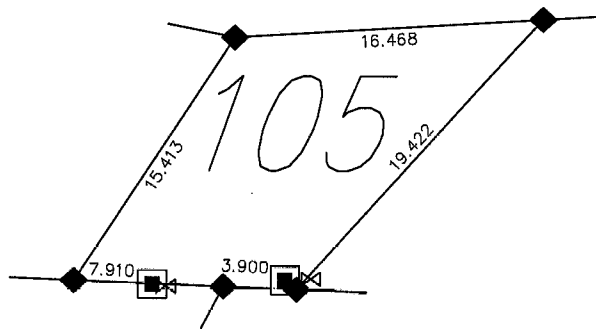

AREA	
sq. m.	= 188.66
sq. ft.	= 2030.7

SCALE  
1:400

PREPARED BY:  
  
**Webb Surveys**  
 07-1622cs B/J

# POPLAR BEACH



## R.V. RESORT

WAKAW LAKE, SASK.

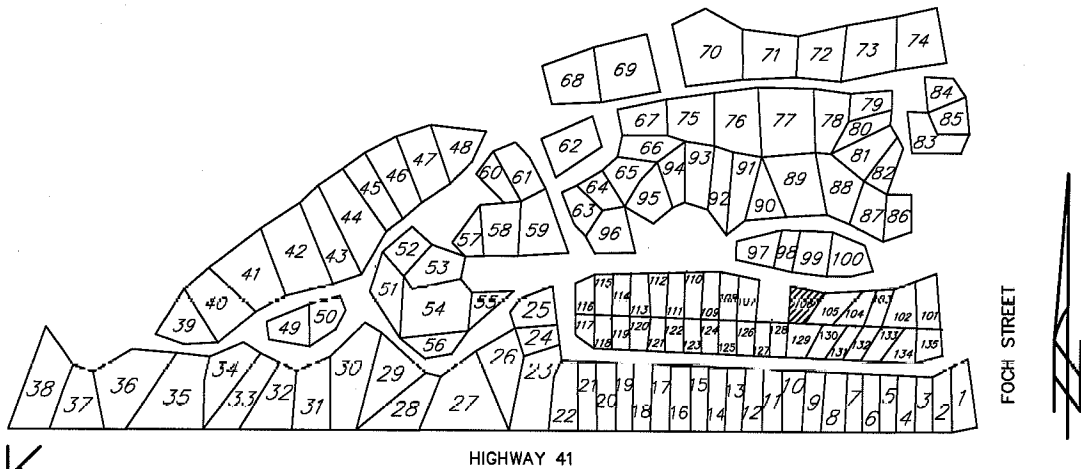

### LEGEND

- Light Pole
- Septic Tank Lid
- ⊗ Water Valve
- Electrical Outlet
- Ⓟ Telephone Pedestal
- ◆ 0.013 X 0.450 m small iron post

### KEY PLAN

HIGHWAY 41

FOCH STREET

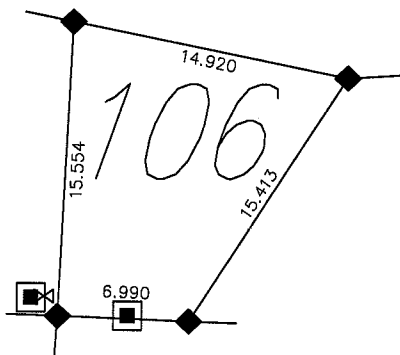

**AREA**  
 sq. m. = 160.86  
 sq. ft. = 1731.5

SCALE  
 1:400

PREPARED BY:  
  
**Webb Surveys**  
 07-1622cs B.J.F.

# POPLAR BEACH



## R. V. RESORT

WAKAW LAKE, SASK.

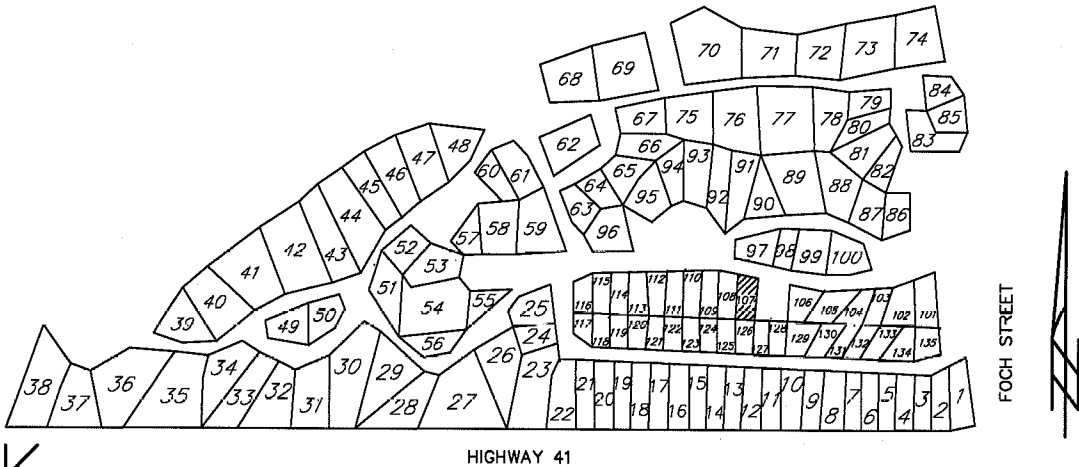

### LEGEND

- Light Pole
- Septic Tank Lid
- ⊗ Water Valve
- Electrical Outlet
- Telephone Pedestal
- ◆ 0.013 X 0.450 m small iron post

### KEY PLAN

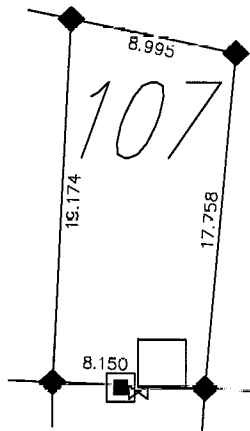

AREA	
sq. m.	= 157.54
sq. ft.	= 1695.7

SCALE  
1: 400

PREPARED BY:  
  
**Webb Surveys**  
 07-1622cs B.J.F.

# POPLAR BEACH



## R. V. RESORT

WAKAW LAKE, SASK.

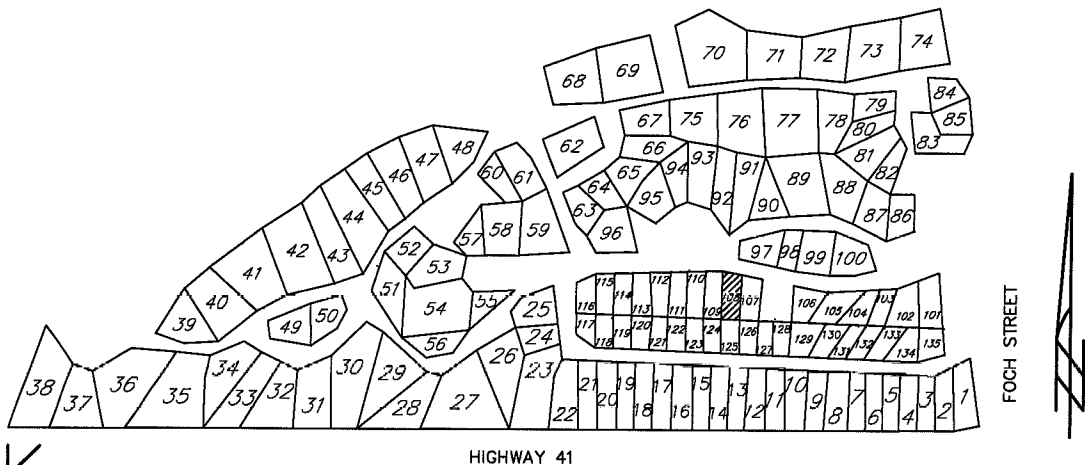

### LEGEND

- Light Pole
- Septic Tank Lid
- ⊗ Water Valve
- Electrical Outlet
- Ⓟ Telephone Pedestal
- ◆ 0.013 X 0.450 m small iron post

### KEY PLAN

HIGHWAY 41

FOCH STREET

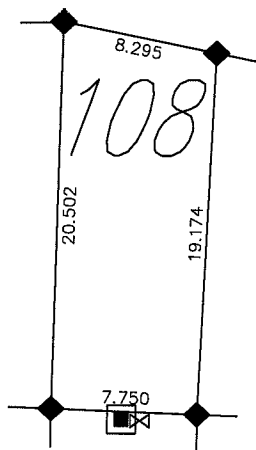

AREA	
sq. m.	= 158.09
sq. ft.	= 1701.6

SCALE  
1:400

PREPARED BY:

Webb Surveys

07-1622cs B/J

# POPLAR BEACH



## R.V. RESORT

WAKAW LAKE, SASK.

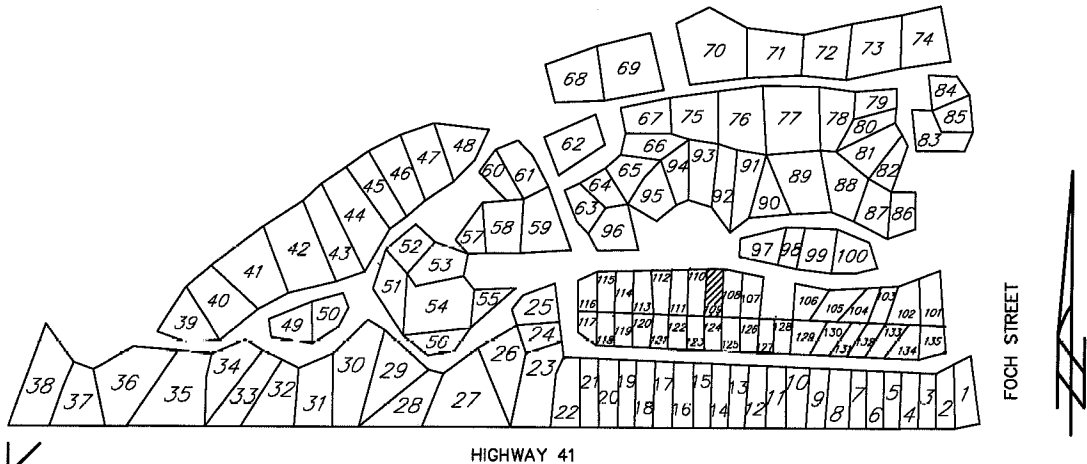

KEY PLAN

HIGHWAY 41

FOCH STREET

**LEGEND**

- Light Pole
- Septic Tank Lid
- ⊗ Water Valve
- Electrical Outlet
- Ⓟ Telephone Pedestal
- ◆ 0.013 X 0.450 m small iron post

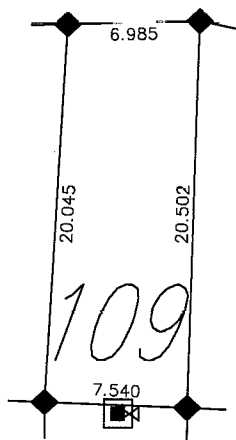

**AREA**  
 sq. m. = 147.05  
 sq. ft. = 1582.8

SCALE  
 1:400

PREPARED BY:

*Webb Surveys*

07-1622cs B.J.F.

# POPLAR BEACH



## R.V. RESORT

WAKAW LAKE, SASK.

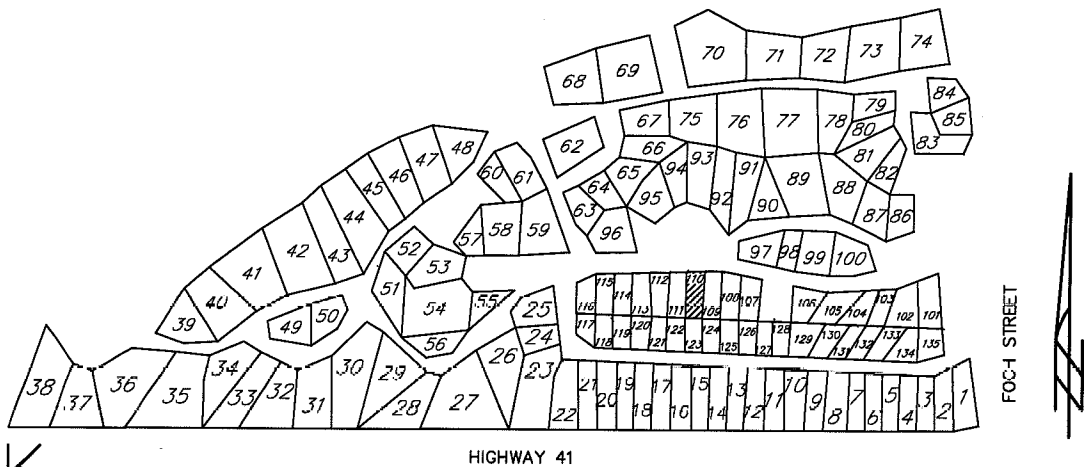

KEY PLAN

HIGHWAY 41

FOCH STREET

**LEGEND**

- Light Pole
- Septic Tank Lid
- ⊗ Water Valve
- Electrical Outlet
- Ⓟ Telephone Pedestal
- ◆ 0.013 X 0.450 m small iron post

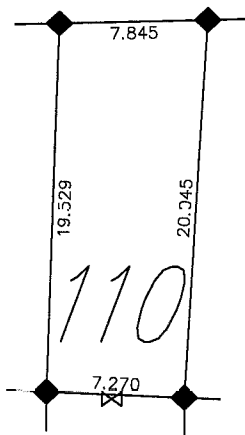

**AREA**  
 sq. m. = 149.34  
 sq. ft. = 1607.4

SCALE  
 1:400

PREPARED BY:

*Webb Surveys*

07-1622cs B.J.F.

# POPLAR BEACH



## R. V. RESORT

WAKAW LAKE, SASK.

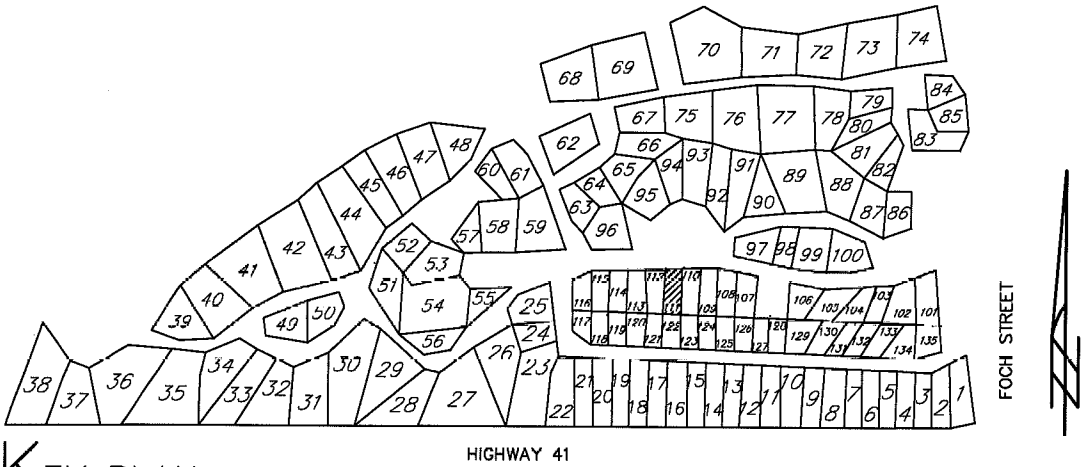

### LEGEND

- Light Pole
- Septic Tank Lid
- ⊗ Water Valve
- Electrical Outlet
- Ⓟ Telephone Pedestal
- ◆ 0.013 X 0.450 m small iron post

### KEY PLAN

HIGHWAY 41

FOCH STREET

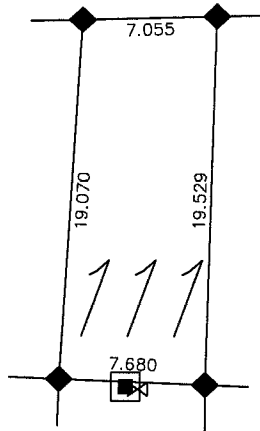

### AREA

sq. m. = 141.99  
sq. ft. = 1528.4

SCALE  
1:400

PREPARED BY:

Webb Surveys

07-1622cs B.J.F.

# POPLAR BEACH



## R. V. RESORT

WAKAW LAKE, SASK.

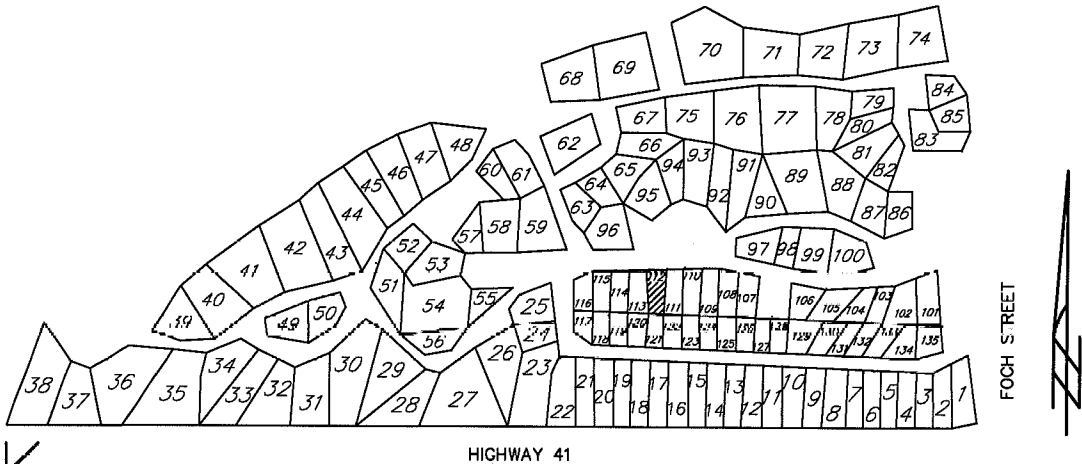

KEY PLAN

HIGHWAY 41

FOCH STREET

### LEGEND

- Light Pole
- Septic Tank Lid
- ⊗ Water Valve
- Electrical Outlet
- Ⓟ Telephone Pedestal
- ◆ 0.013 X 0.450 m small iron post

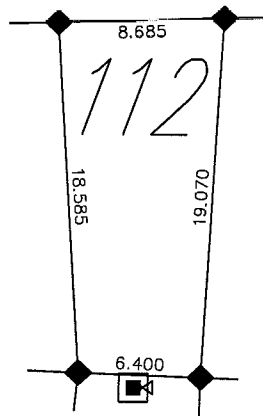

**AREA**  
 sq. m. = 141.67  
 sq. ft. = 1524.9

SCALE  
 1:400

PREPARED BY:

*Webb Surveys*

07-1622cs BJJ



# POPLAR BEACH



## R.V. RESORT

WAKAW LAKE, SASK.

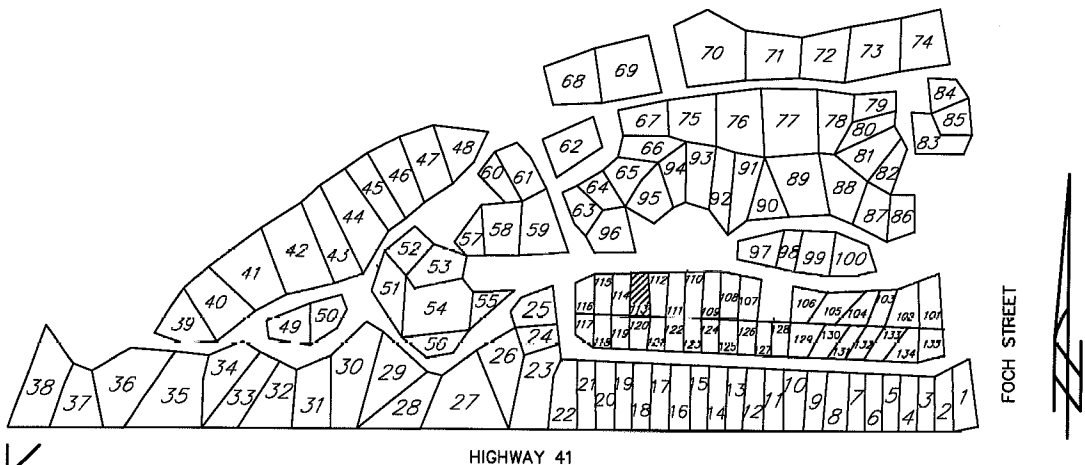

KEY PLAN

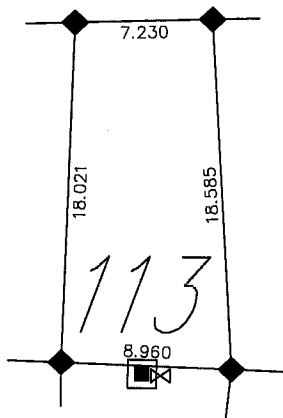

**AREA**  
 sq. m. = 147.88  
 sq. ft. = 1591.8

SCALE  
 1:400

PREPARED BY:  
  
**Webb Surveys**  
 07-1622cs B.J.F.

# POPLAR BEACH



## R. V. RESORT

WAKAW LAKE, SASK.

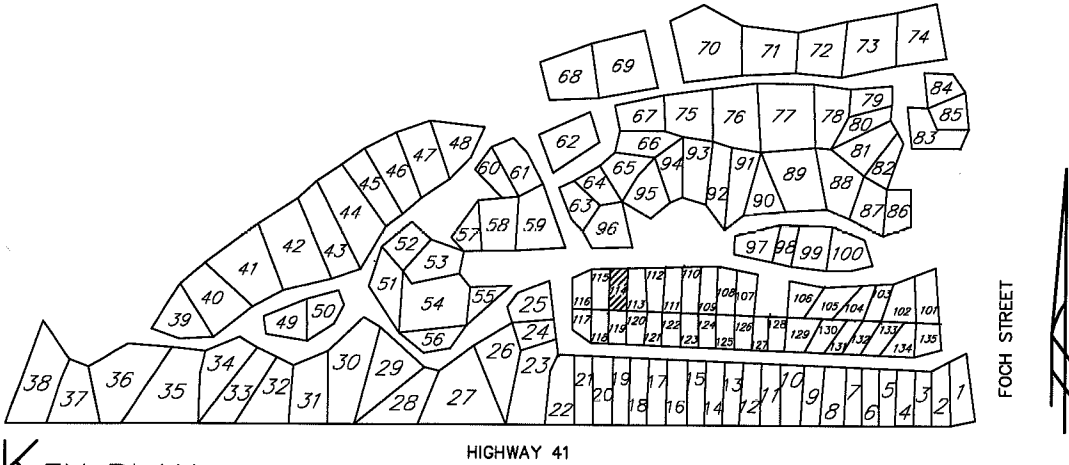

### LEGEND

- Light Pole
- Septic Tank Lid
- ⊗ Water Valve
- Electrical Outlet
- Ⓟ Telephone Pedestal
- ◆ 0.013 X 0.450 m small iron post

### KEY PLAN

HIGHWAY 41

FOCH STREET

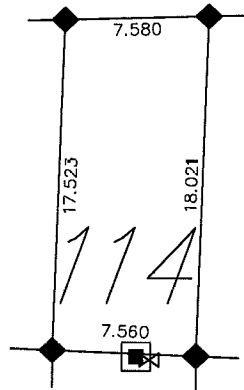

**AREA**  
 sq. m. = 134.41  
 sq. ft. = 1446.8

SCALE  
 1:400

PREPARED BY:

**Webb Surveys**

07-1622cs B/J

# POPLAR BEACH



## R.V. RESORT

WAKAW LAKE, SASK.

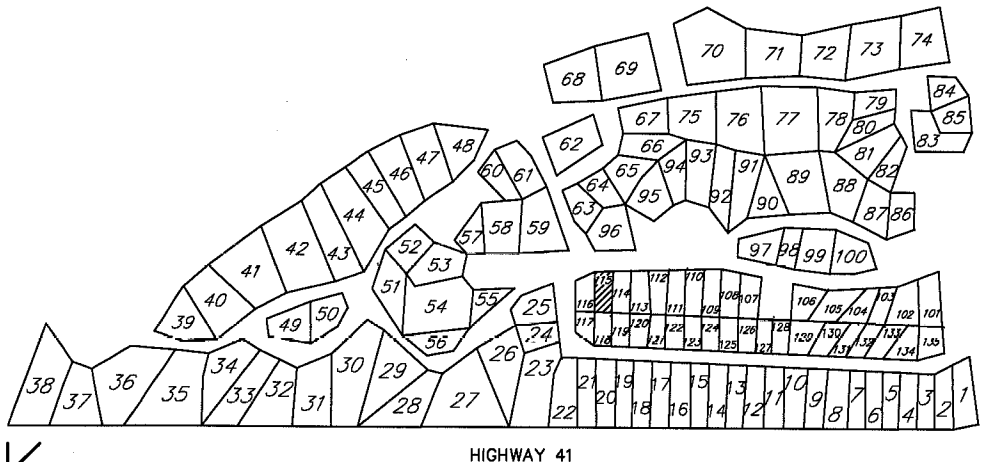

### LEGEND

- Light Pole
- Septic Tank Lid
- ⊗ Water Valve
- Electrical Outlet
- Telephone Pedestal
- ◆ 0.013 X 0.450 m small iron post

### KEY PLAN

HIGHWAY 41

FOCH STREET

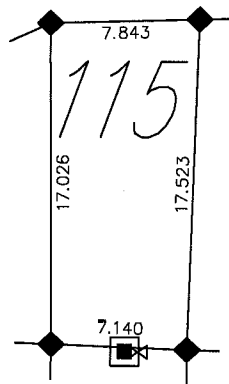

**AREA**  
 sq. m. = 129.31  
 sq. ft. = 1391.9

SCALE  
 1:400

PREPARED BY:



07-1622cs B.J.F.

# POPLAR BEACH

## R.V. RESORT

WAKAW LAKE, SASK.

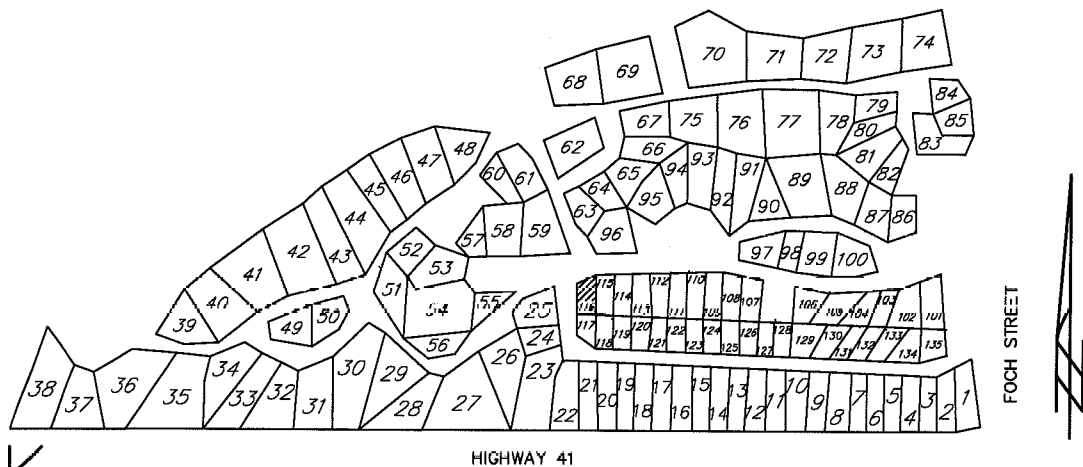

### LEGEND

- Light Pole
- Septic Tank Lid
- ⊗ Water Valve
- Electrical Outlet
- Ⓟ Telephone Pedestal
- ◆ 0.013 X 0.450 m small iron post

### KEY PLAN

HIGHWAY 41

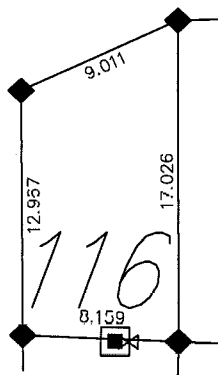

**AREA**  
 sq. m. = 122.82  
 sq. ft. = 1322.0

SCALE  
 1:400

PREPARED BY:  
  
**Webb Surveys**  
 07-1622cs DJF

# POPLAR BEACH



## R.V. RESORT

WAKAW LAKE, SASK.

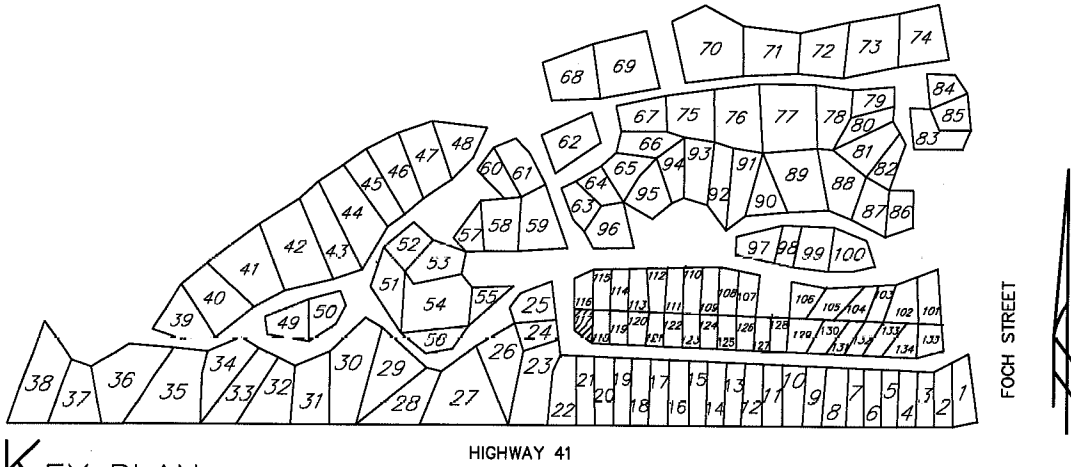

KEY PLAN

HIGHWAY 41

FOCH STREET

### LEGEND

- Light Pole
- Septic Tank Lid
- ⊗ Water Valve
- Electrical Outlet
- Telephone Pedestal
- ◆ 0.013 X 0.450 m small iron post

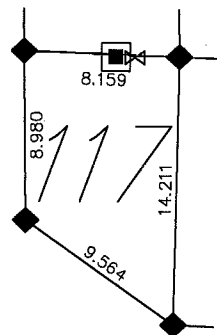

**AREA**  
 sq. m. = 92.65  
 sq. ft. = 997.3

SCALE  
 1:400

PREPARED BY:

*Webb Surveys*

07-1622cs B.J.F.

# POPLAR BEACH



## R. V. RESORT

WAKAW LAKE, SASK.

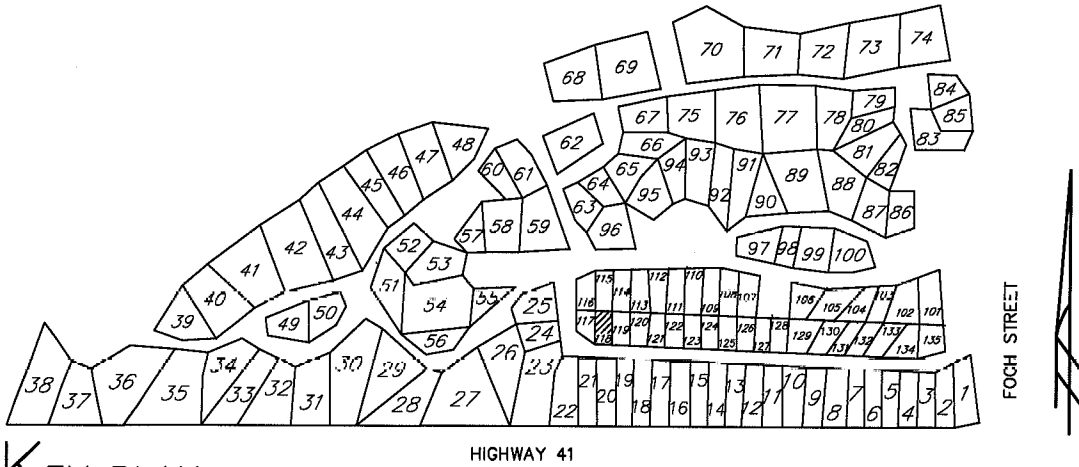

KEY PLAN

HIGHWAY 41

FOCH STREET

### LEGEND

- Light Pole
- Septic Tank Lid
- ⊗ Water Valve
- Electrical Outlet
- Ⓟ Telephone Pedestal
- ◆ 0.013 X 0.450 m small iron post

### AREA

sq. m. = 103.16  
sq. ft. = 1110.4

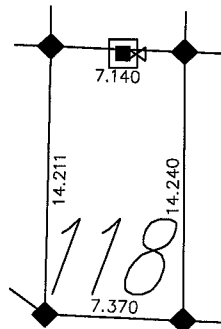

SCALE  
1:400

PREPARED BY:

*Webb Surveys*

07-1622cs BJF

# POPLAR BEACH



## R. V. RESORT

WAKAW LAKE, SASK.

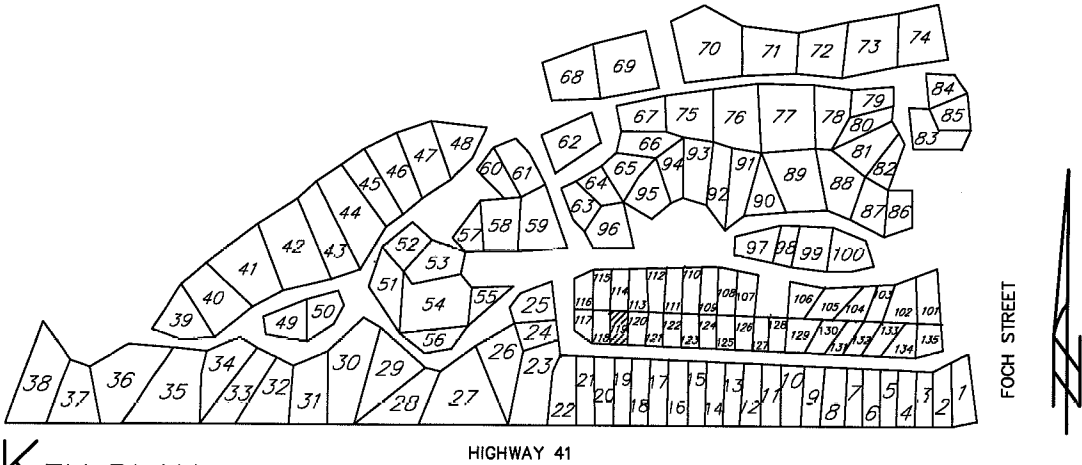

### LEGEND

- Light Pole
- Septic Tank Lid
- ⊗ Water Valve
- Electrical Outlet
- Telephone Pedestal
- ◆ 0.013 X 0.450 m small iron post

### KEY PLAN

HIGHWAY 41

FOCH STREET

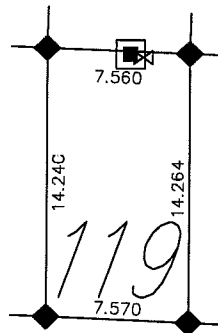

AREA	
sq. m. -	107.73
sq. ft. =	1159.6

SCALE  
1:400

PREPARED BY:

Webb Surveys

07-1622cs BJB

# POPLAR BEACH



## R. V. RESORT

WAKAW LAKE, SASK.

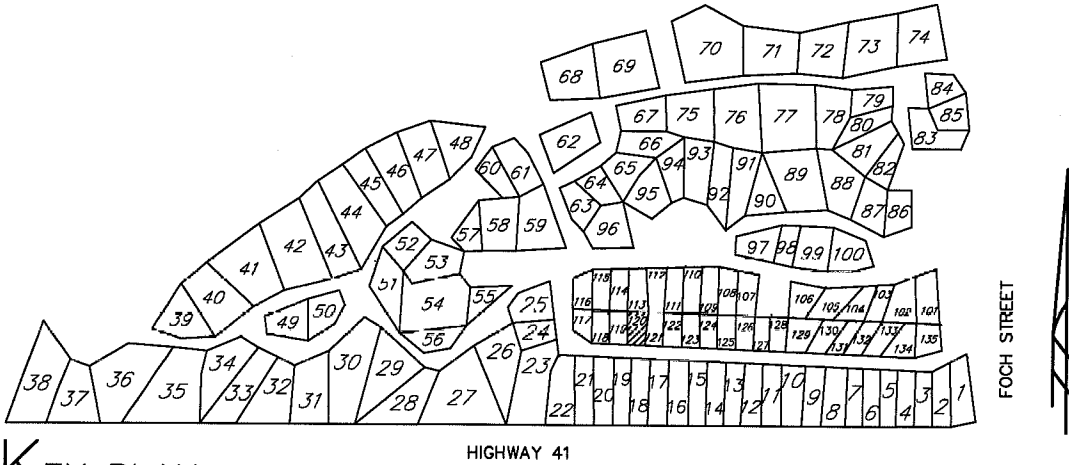

### LEGEND

- Light Pole
- Septic Tank Lid
- ⊗ Water Valve
- Electrical Outlet
- Ⓟ Telephone Pedestal
- ◆ 0.013 X 0.450 m small iron post

### KEY PLAN

HIGHWAY 41

FOCH STREET

### AREA

sq. m. = 117.19  
sq. ft. = 1261.4

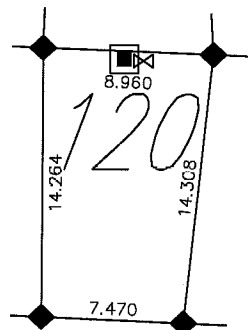

SCALE  
1:400

PREPARED BY:

Webb Surveys

07-1622cs BJB



# POPLAR BEACH



## R. V. RESORT

WAKAW LAKE, SASK.

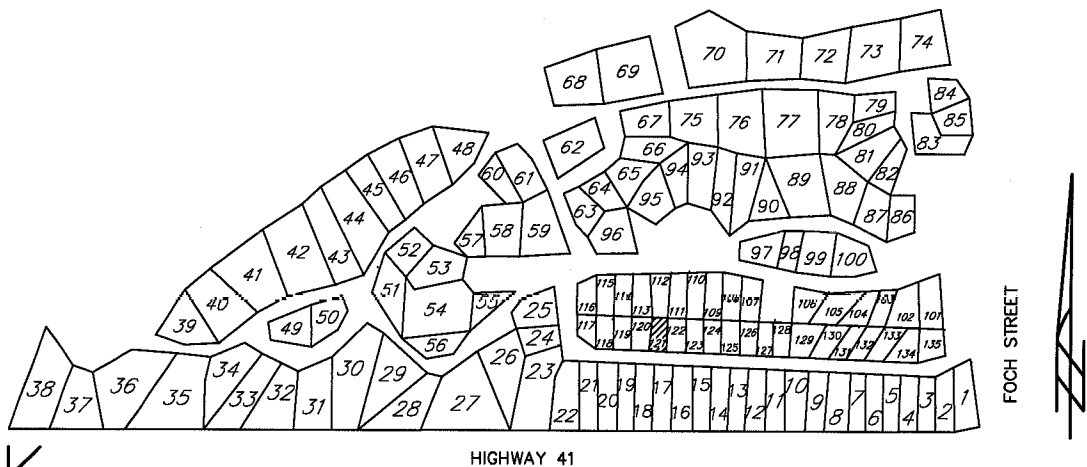

KEY PLAN

HIGHWAY 41

FOCH STREET

### LEGEND

- Light Pole
- Septic Tank Lid
- ⊗ Water Valve
- Electrical Outlet
- Telephone Pedestal
- ◆ 0.013 X 0.450 m small iron post

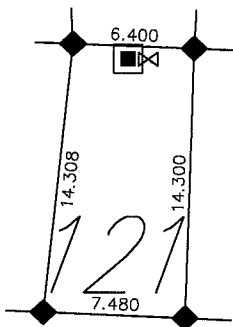

**AREA**  
 sq. m. = 99.16  
 sq. ft. = 1067.4

SCALE  
 1:400

PREPARED BY:

*Webb Surveys*

07-1622cs B.J.F.

# POPLAR BEACH



## R. V. RESORT

WAKAW LAKE, SASK.

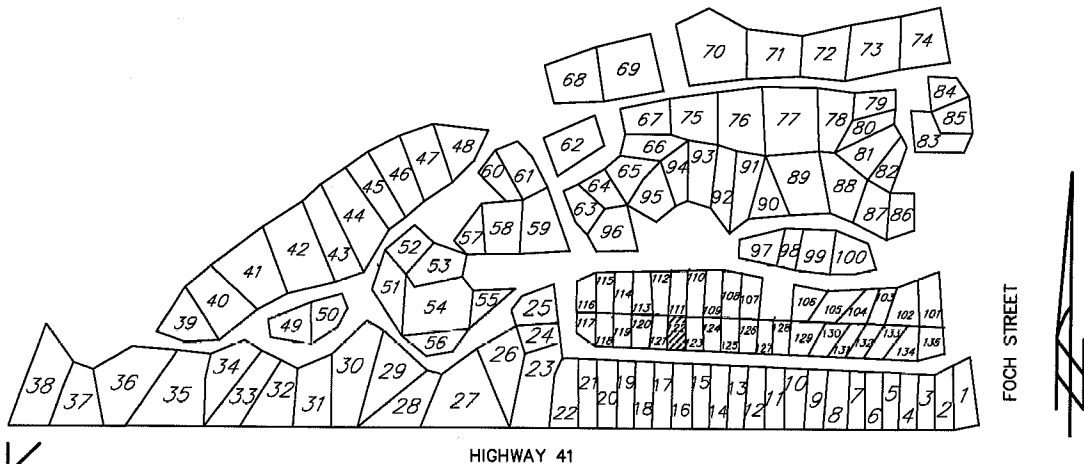

KEY PLAN

HIGHWAY 41

FOCH STREET

### LEGEND

- Light Pole
- Septic Tank Lid
- ⊗ Water Valve
- Electrical Outlet
- Telephone Pedestal
- ◆ 0.013 X 0.450 m small iron post

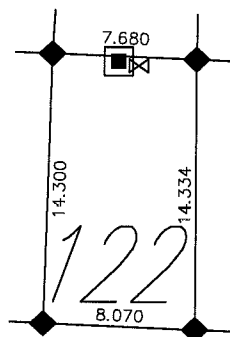

**AREA**  
 sq. m. = 112.70  
 sq. ft. = 1213.1

SCALE  
 1:400

PREPARED BY:

**Webb Surveys**

07-1622cs BJB

# POPLAR BEACH



## R. V. RESORT

WAKAW LAKE, SASK.

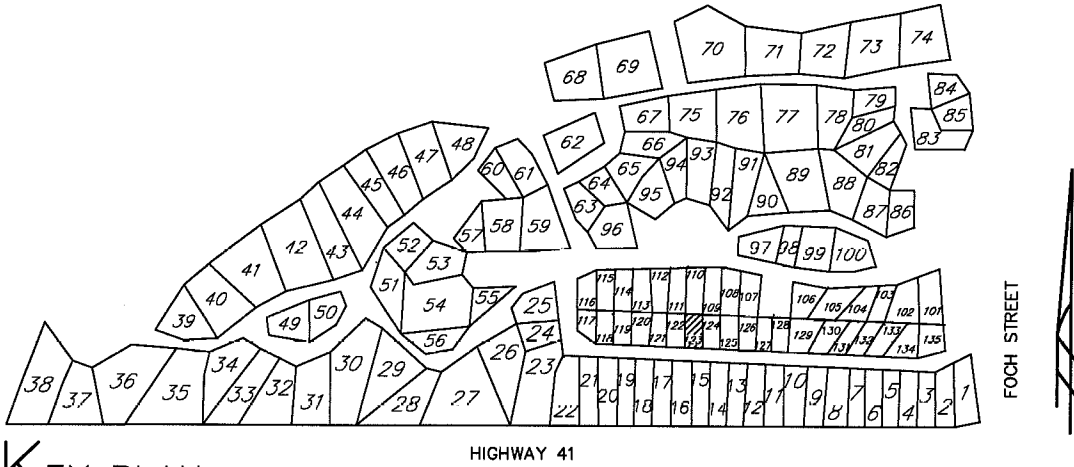

### LEGEND

- Light Pole
- Septic Tank Lid
- ⊗ Water Valve
- Electrical Outlet
- Ⓟ Telephone Pedestal
- ◆ 0.013 X 0.450 m small iron post

### KEY PLAN

HIGHWAY 41

FOCH STREET

### AREA

sq. m. = 106.22  
sq. ft. = 1143.4

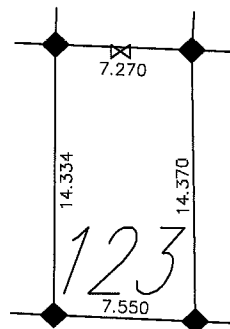

SCALE  
1:400

PREPARED BY:

Webb Surveys

07-1622cs B.J.F.

# POPLAR BEACH



## R. V. RESORT

WAKAW LAKE, SASK.

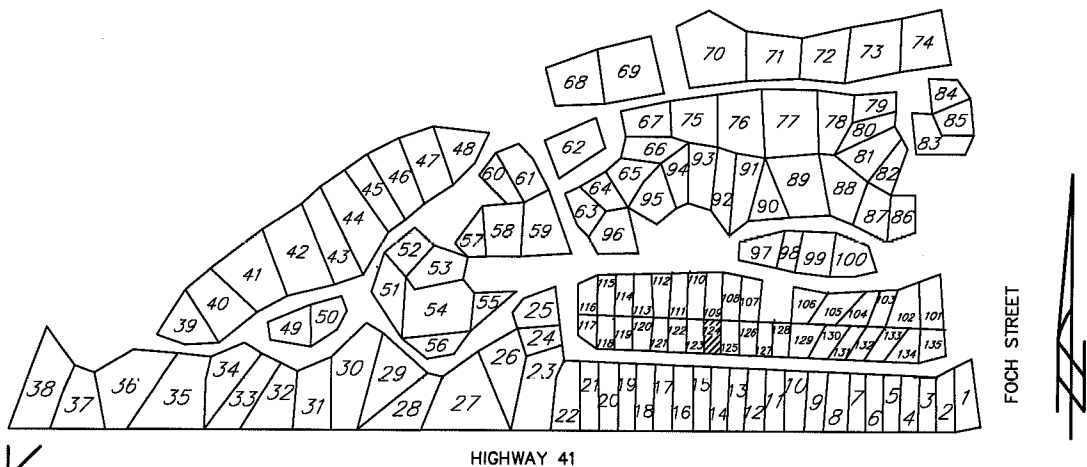

### LEGEND

- Light Pole
- Septic Tank Lid
- ⊗ Water Valve
- Electrical Outlet
- Telephone Pedestal
- ◆ 0.013 X 0.450 m small iron post

### KEY PLAN

HIGHWAY 41

FOCH STREET

**AREA**  
 sq. m. = 105.74  
 sq. ft. = 1138.2

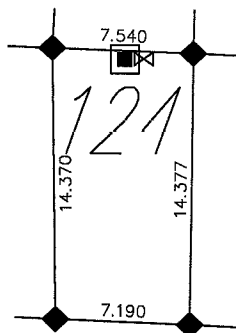

SCALE  
 1:400

PREPARED BY:

*Webb Surveys*

07-1622cs B.J.F.

# POPLAR BEACH



## R. V. RESORT

WAKAW LAKE, SASK.

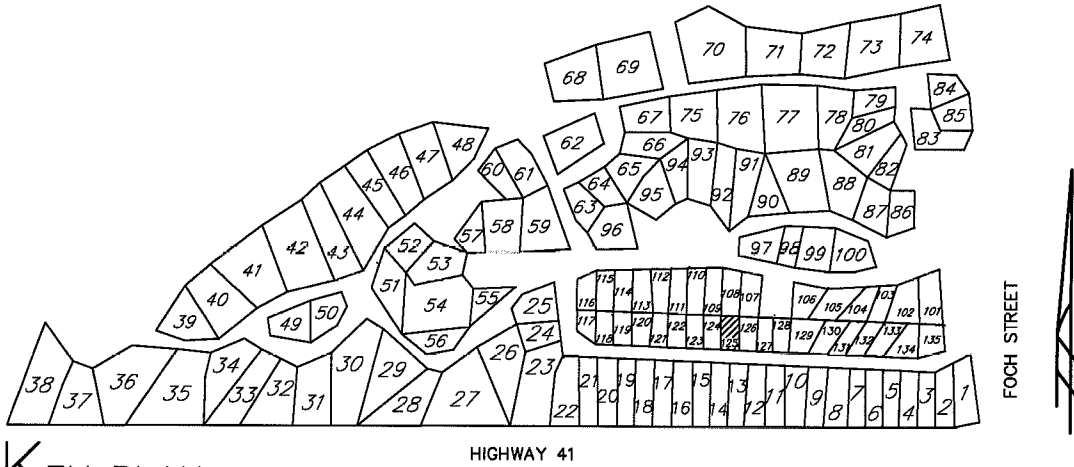

### LEGEND

- Light Pole
- Septic Tank Lid
- ⊗ Water Valve
- Electrical Outlet
- Telephone Pedestal
- ◆ 0.013 X 0.450 m small iron post

### KEY PLAN

**AREA**  
 sq. m. = 111.67  
 sq. ft. = 1202.0

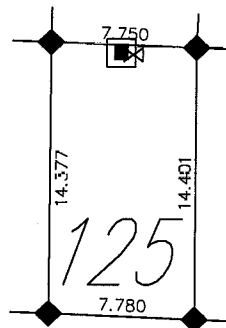

SCALE  
1:400

PREPARED BY:

**Webb Surveys**

07-1622cs B/J

# POPLAR BEACH



## R. V. RESORT

WAKAW LAKE, SASK.

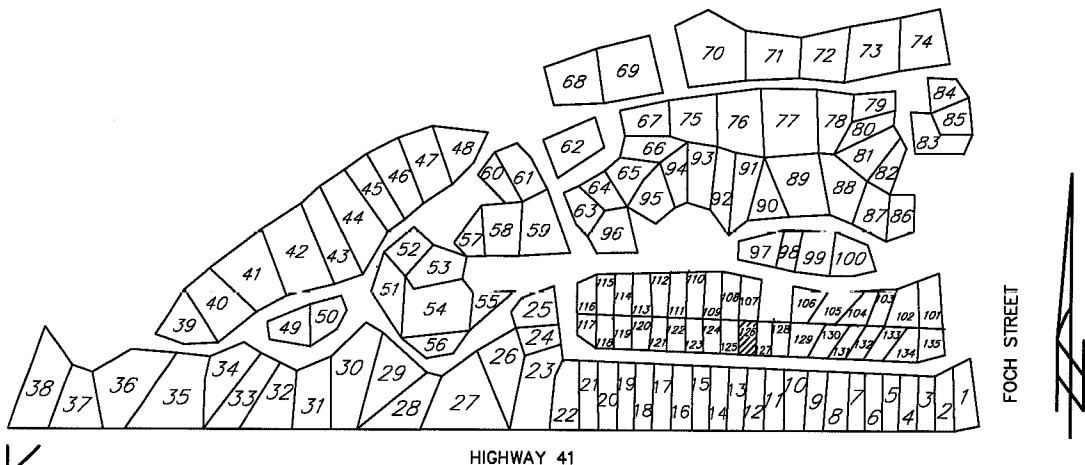

### LEGEND

- Light Pole
- Septic Tank Lid
- ⊗ Water Valve
- Electrical Outlet
- Ⓟ Telephone Pedestal
- ◆ 0.013 X 0.450 m small iron post

### KEY PLAN

HIGHWAY 41

FOCH STREET

**AREA**  
 sq. m. = 111.42  
 sq. ft. = 1199.3

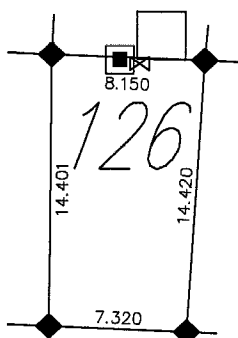

SCALE  
1:400

PREPARED BY:

*Webb Surveys*

07-1622cs BJJ

# POPLAR BEACH



## R. V. RESORT

WAKAW LAKE, SASK.

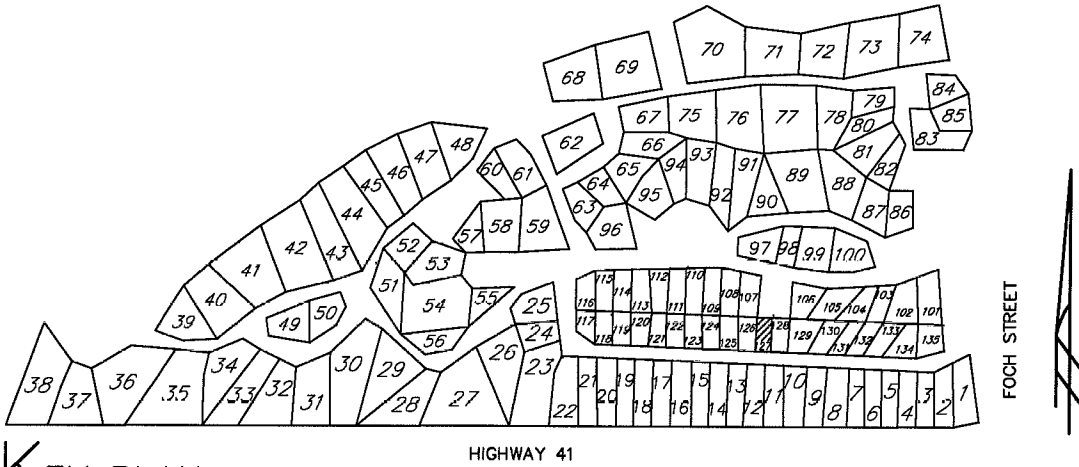

KEY PLAN

HIGHWAY 41

FOCH STREET

**LEGEND**

- Light Pole
- Septic Tank Lid
- ⊠ Water Valve
- Electrical Outlet
- Telephone Pedestal
- ◆ 0.013 X 0.450 m small iron post

**AREA**  
 sq. m. = 95.29  
 sq. ft. = 1025.7

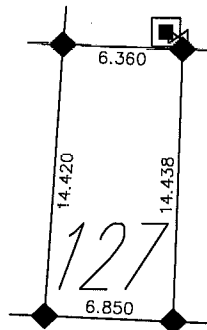

SCALE  
1:400

PREPARED BY:



07-1022cs B.J.F.

# POPLAR BEACH



## R. V. RESORT

WAKAW LAKE, SASK.

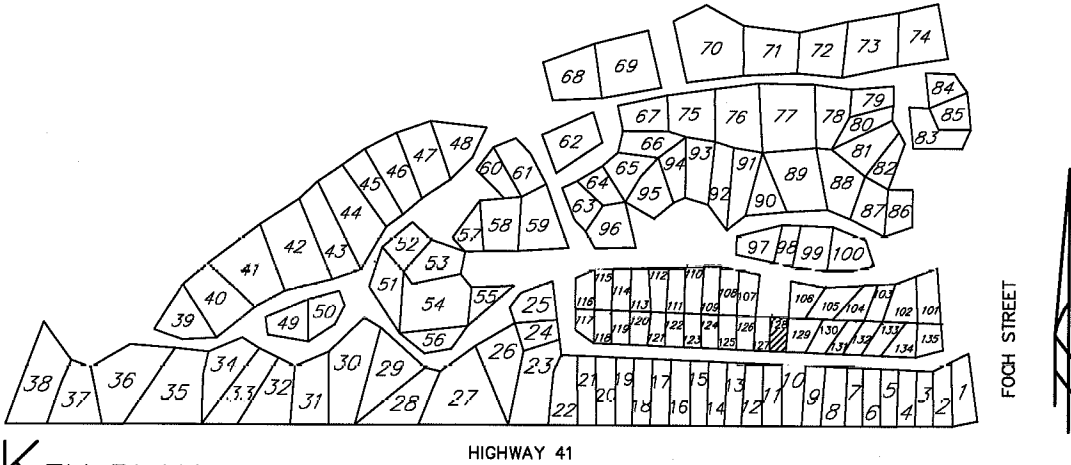

### LEGEND

- Light Pole
- Septic Tank Lid
- ⊗ Water Valve
- Electrical Outlet
- Telephone Pedestal
- ◆ 0.013 X 0.45U m small iron post

### KEY PLAN

HIGHWAY 41

FOCH STREET

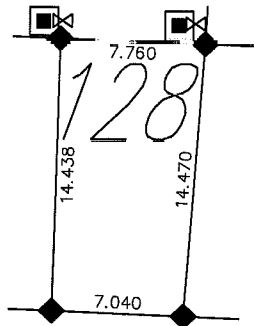

### AREA

sq. m. = 106.92  
sq. ft. = 1150.8

SCALE  
1: 400

PREPARED BY:

Webb Surveys

07-1622cs B.J.F.



# POPLAR BEACH



## R. V. RESORT

WAKAW LAKE, SASK.

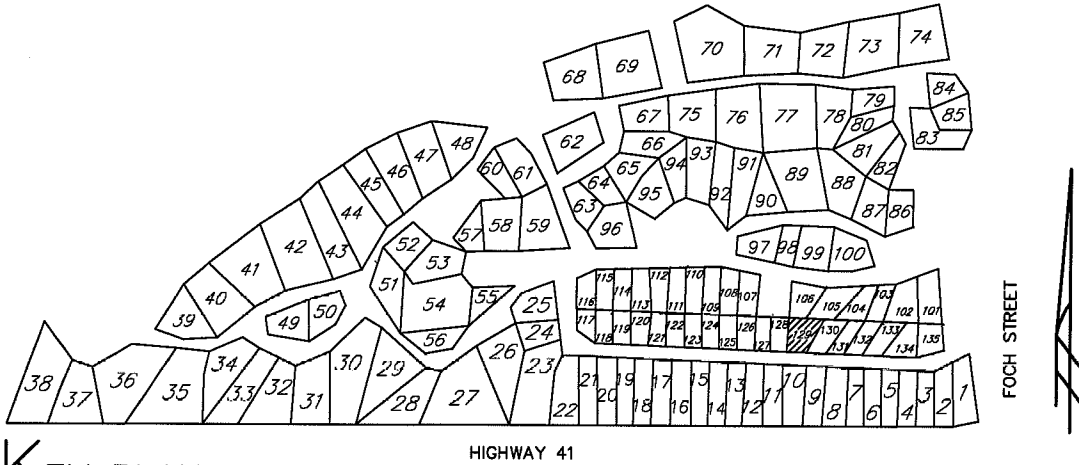

### LEGEND

- Light Pole
- Septic Tank Lid
- ⊗ Water Valve
- Electrical Outlet
- Telephone Pedestal
- ◆ 0.013 X 0.450 m small iron post

### KEY PLAN

HIGHWAY 41

FOUCH STREET

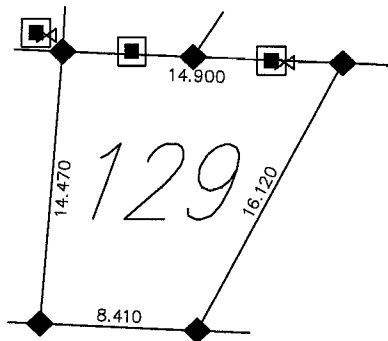

### AREA

sq. m. = 168.71  
sq. ft. = 1816.0

SCALE  
1:400

PREPARED BY:

Webb Surveys

07-1622cs B/J

# POPLAR BEACH



## R. V. RESORT

WAKAW LAKE, SASK.

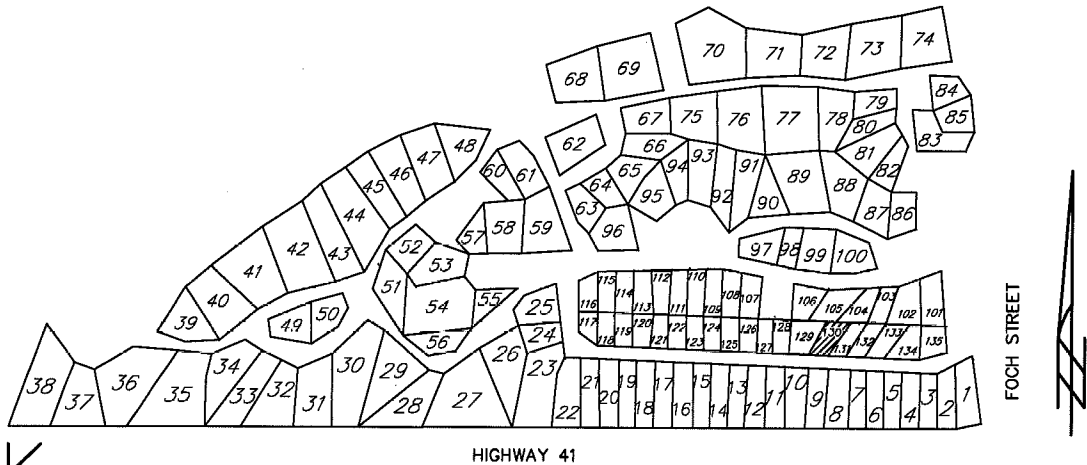

KEY PLAN

HIGHWAY 41

FOCH STREET

**LEGEND**

- Light Pole
- Septic Tank Lid
- ⊗ Water Valve
- Electrical Outlet
- Telephone Pedestal
- ◆ 0.013 X 0.450 m small iron post

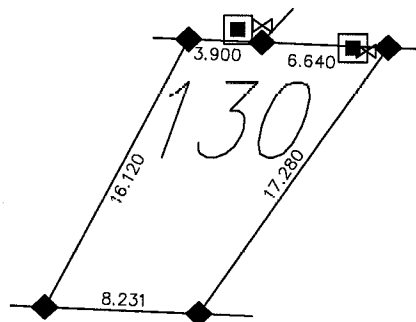

**AREA**  
 sq. m. = 136.16  
 sq. ft. = 1465.6

SCALE  
 1:400

PREPARED BY:

*Webb Surveys*

07-1622cs B.J.F.

# POPLAR BEACH

## R.V. RESORT

WAKAW LAKE, SASK.

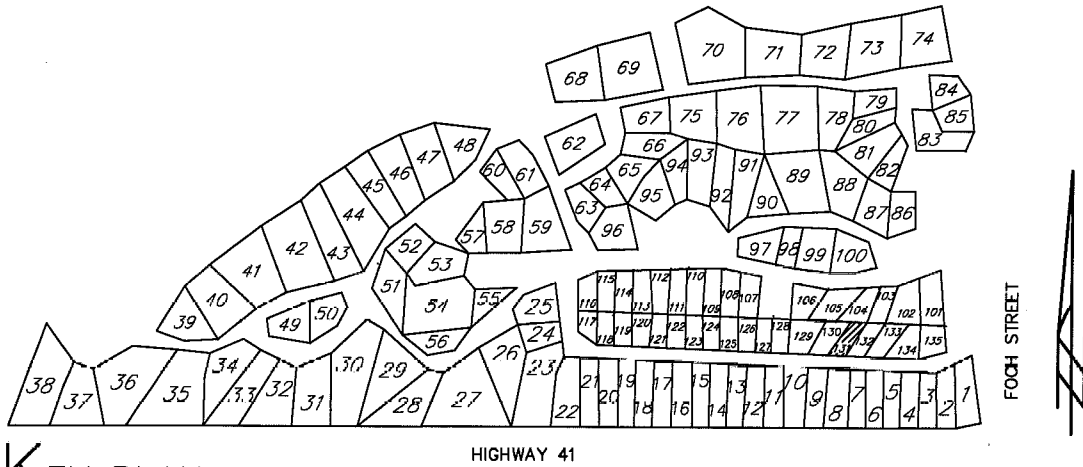

KEY PLAN

**LEGEND**

- Light Pole
- Septic Tank Lid
- ⊗ Water Valve
- Electrical Outlet
- Telephone Pedestal
- ◆ 0.013 X 0.450 m small iron post

**AREA**  
 sq. m. = 103.79  
 sq. ft. = 1117.1

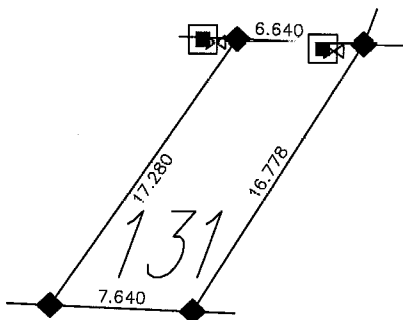

SCALE  
1:400

PREPARED BY:  
  
**Webb Surveys**  
 07-1622cs BJF

# POPLAR BEACH



## R. V. RESORT

WAKAW LAKE, SASK.

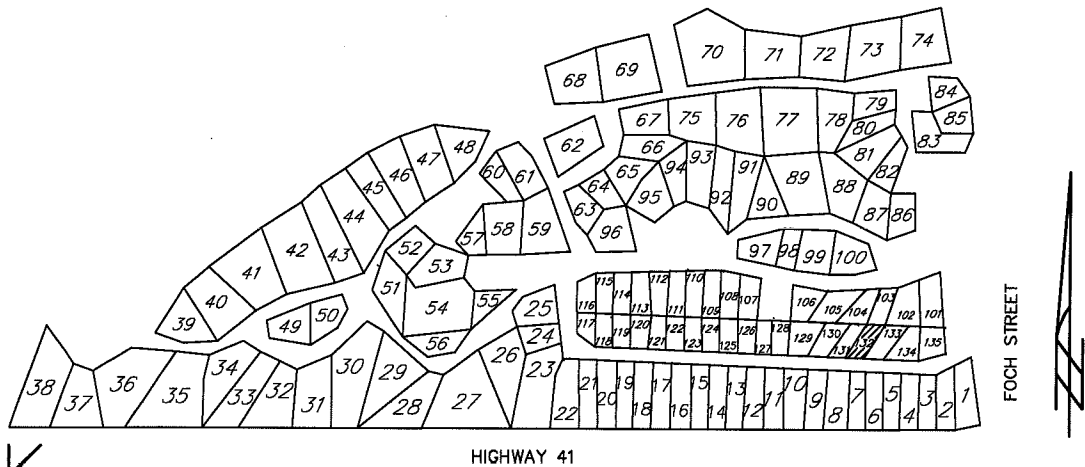

### LEGEND

- Light Pole
- Septic Tank Lid
- ⊗ Water Valve
- Electrical Outlet
- Telephone Pedestal
- ◆ 0.013 X 0.450 m small iron post

### KEY PLAN

HIGHWAY 41

FOCH STREET

**AREA**  
 sq. m. = 114.28  
 sq. ft. = 1230.1

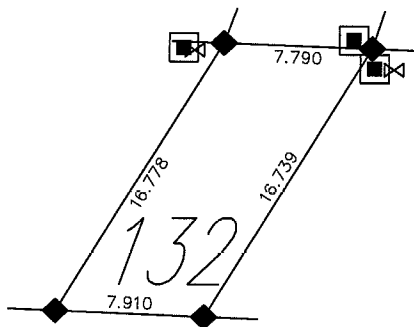

SCALE  
1:400

PREPARED BY:

*Webb Surveys*

07-1622cs BJB

# POPLAR BEACH



## R. V. RESORT

WAKAW LAKE, SASK.

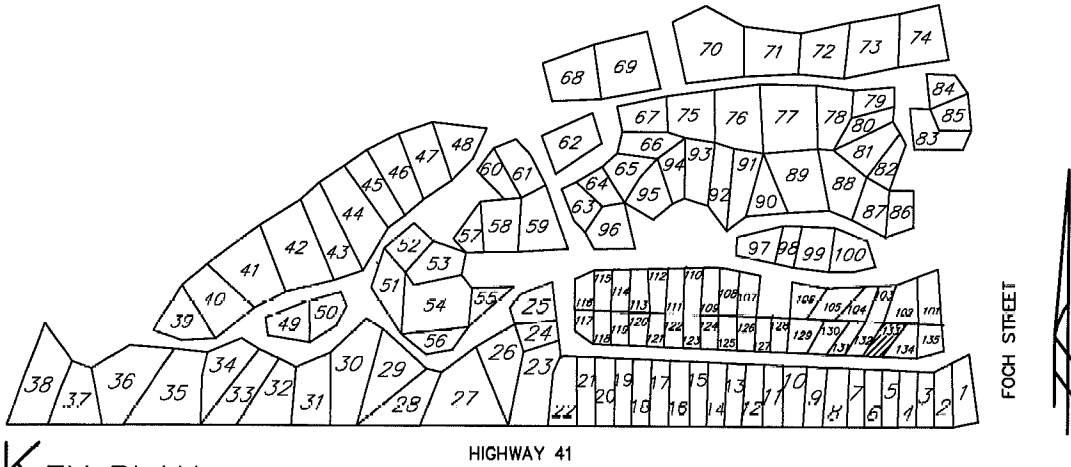

KEY PLAN

HIGHWAY 41

FOCH STREET

### LEGEND

- Light Pole
- Septic Tank Lid
- ⊗ Water Valve
- Electrical Outlet
- Telephone Pedestal
- ◆ 0.013 X 0.450 m small iron post

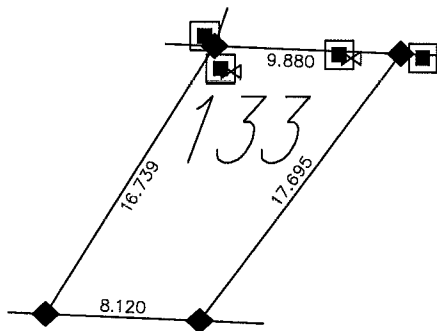

**AREA**  
 sq. m. = 131.24  
 sq. ft. = 1412.7

SCALE  
 1:400

PREPARED BY:

*Webb Surveys*

07-1622cs B/J

# POPLAR BEACH



## R. V. RESORT

WAKAW LAKE, SASK.

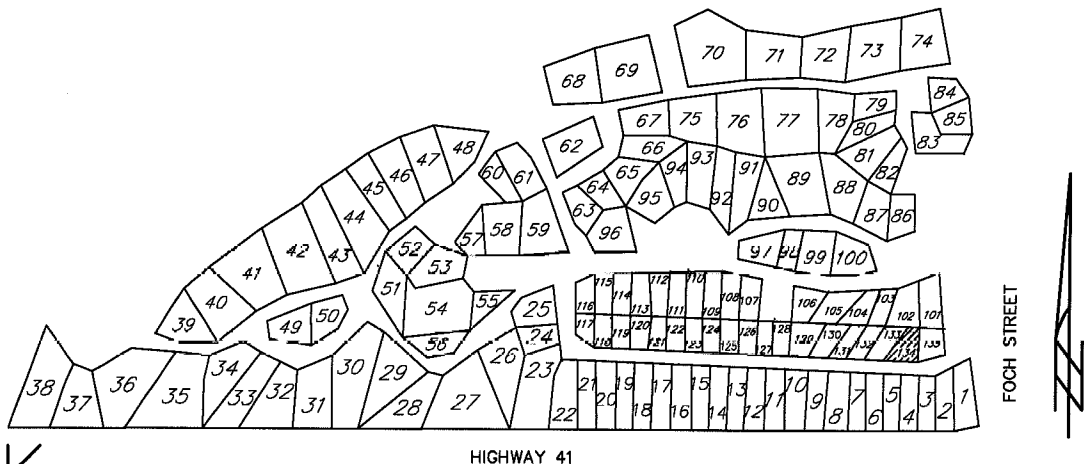

KEY PLAN

**LEGEND**

- Light Pole
- Septic Tank Lid
- ⊗ Water Valve
- Electrical Outlet
- Telephone Pedestal
- ◆ 0.013 X 0.450 m small iron post

HIGHWAY 41

FOCH STREET

**AREA**  
 sq. m. = 144.78  
 sq. ft. = 1558.4

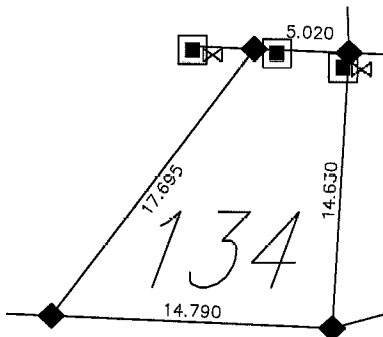

SCALE  
 1:400

PREPARED BY:



07-1622cs B/J

# POPLAR BEACH



## R.V. RESORT

WAKAW LAKE, SASK.

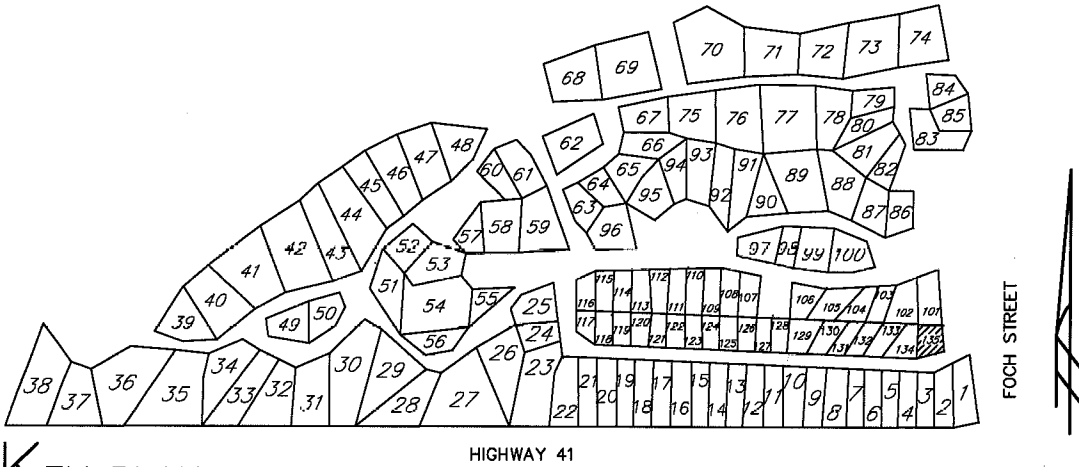

### KEY PLAN

HIGHWAY 41

FOCH STREET

#### LEGEND

- Light Pole
- Septic Tank Lid
- ⊗ Water Valve
- Electrical Outlet
- Ⓟ Telephone Pedestal
- ◆ 0.013 X 0.450 m small iron post

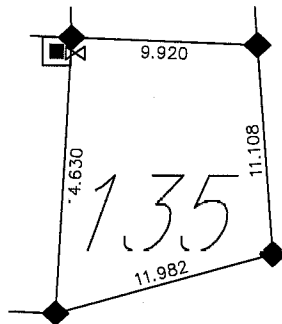

**AREA**  
 sq. m. = 137.89  
 sq. ft. = 1484.3

SCALE  
 1:400

PREPARED BY:



07-1622cs B.J.F.